

03-324 Renewing front crankshaft radial sealing ring

Tightening torques

Nm

Bolt on crankshaft

270-330

Bolts pulley to hub

35

Special tools

Detent (starter flange left or right)

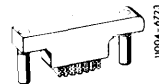

116 589 01 40 00

Torque wrench 3/4" square,
150-500 Nm



001 589 31 21 00

Socket 27 mm, 1/2" square

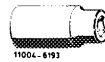

001 589 65 09 00

Bushing for radial sealing ring

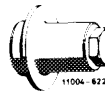

110 589 07 61 00

Conventional tool

Connection 3/4" square socket
to 1/2" socket head

e. g. Hazet, D-5630 Remscheid
order No. 1058 RI

Note

Fill radial sealing ring prior to assembly between
sealing and dust lip with longterm grease according
to sheet 266.2 of Specifications for service products.

Renewing

1 Remove hub, vibration damper and pulley (03-
342).

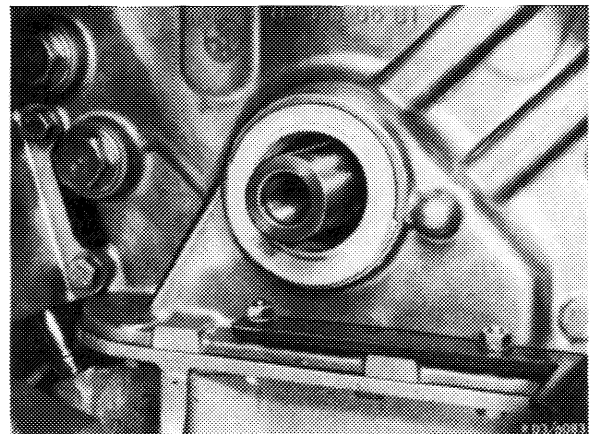

2 Push out radial sealing ring by means of a screw driver.

Attention!

Do not damage crankshaft and receiving bore for radial sealing ring.

3 Deburr edge of receiving bore for radial sealing ring.

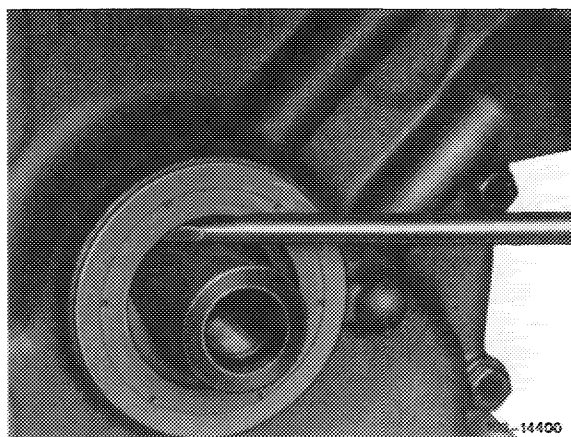

4 Install radial sealing ring with insertion bushing (1). For installation, use hex. screw (107) for attaching hub to crankshaft and a disc spring (106).

The radial sealing ring should be at right angles with crankshaft journal.

Note: Hubs with score marks caused by radial sealing ring must be replaced.

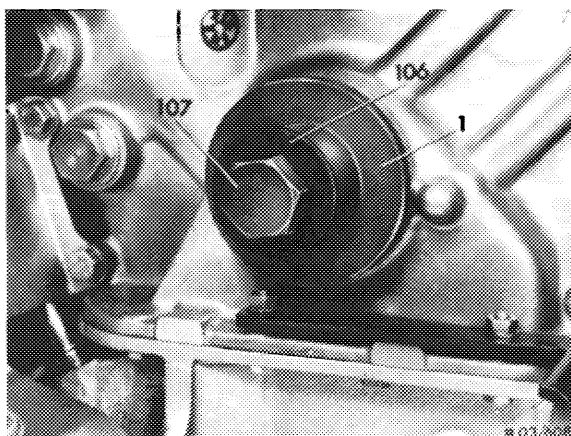

5 Install hub, vibration damper and pulley (03-342).

Mount screw M 18 x 1.5 x 45 with 4 disc washers (on light alloy engines with 3 disc washers).

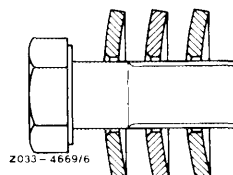

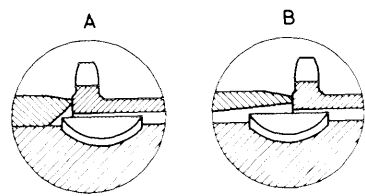

Detail X

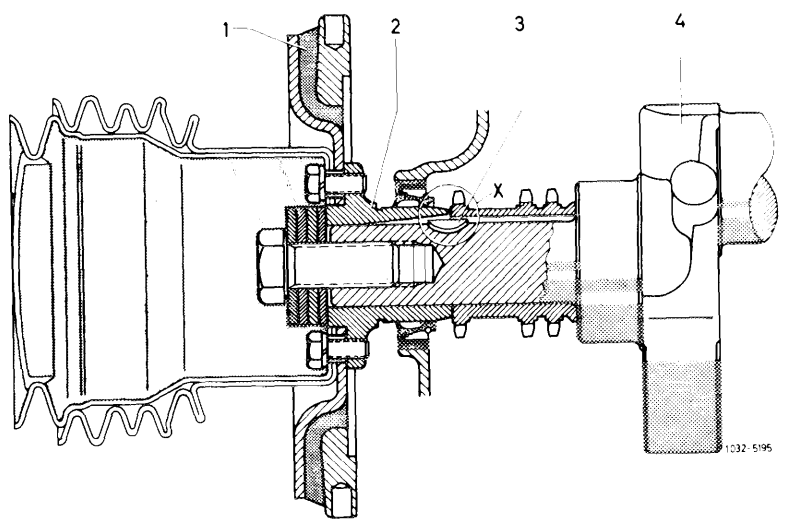

- A 1st version
- B 2nd version