

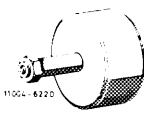

05–330 Removal and installation of tensioning rail

Tightening torques		Nm
Bolts for cylinder head cover		3
Screw for camshaft sprocket		100
Special tools		
Impact puller for bearing bolt (basic unit)		116 589 20 33 00
Threaded bolt M 6 x 50		116 589 01 34 00

Note

The timing chain is guided in cylinder crankcase by 2 slide rails and tensioned by means of chain tensioner and a tensioning rail.

The tensioning rail is guided by a bolt which is floatingly supported in cylinder crankcase and in timing housing cover.

The tensioning rails of engines 116.98 and 117.98 are of different length and differ in shape from those of light alloy engines.

Coating (3) of tensioning rails of all engines 116 and 117 can be replaced in the event of repairs.

1	Tensioning rail		
	engine	116.96	117.96
	a =	133 mm	160 mm
2	Tensioning rail		
	engine	116.98	117.98
	b =	133 mm	161.5 mm
3	Coating		
	engine	116	117
	c =	184 mm	208 mm

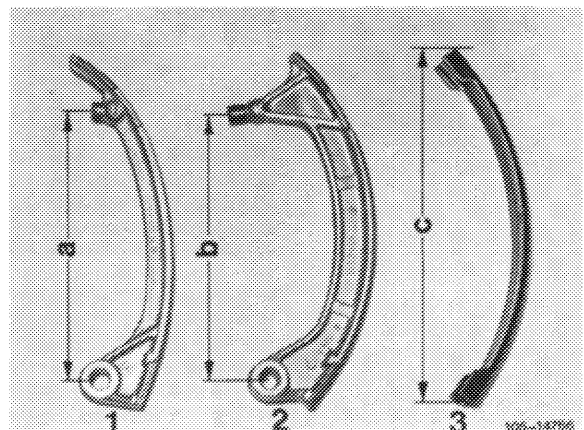

Note

The steel tensioning rail (1) can be exchanged for aluminum tensioning rail (2).

The plastic lining (3) on aluminum tensioning rail (2) is replaceable.

Engine 116 dimension a = 133 mm

Engine 117 dimension a = 161.5 mm

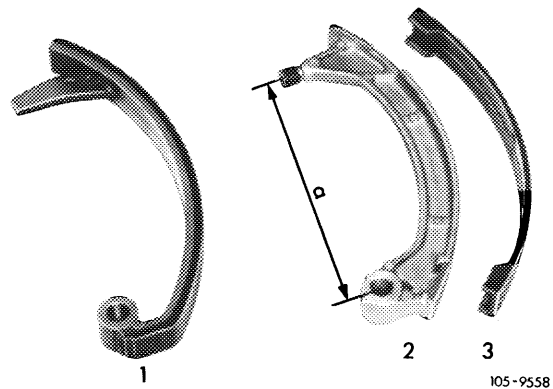

Removal

1 On engines with aluminum tensioning rail, remove alternator with mounting bracket and remove slide rail in righthand cylinder head.

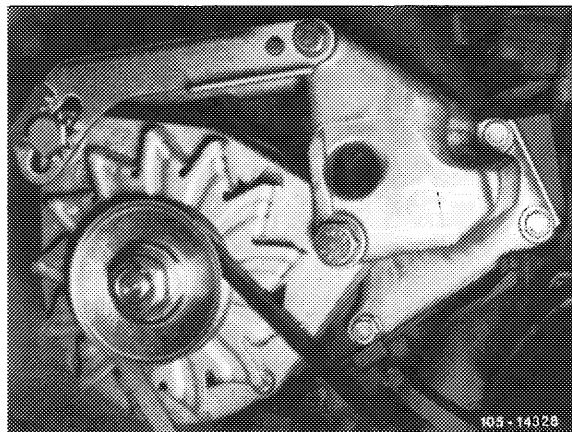

2 Mark righthand camshaft sprocket and timing chain together with paint.

3 Remove righthand camshaft gear.

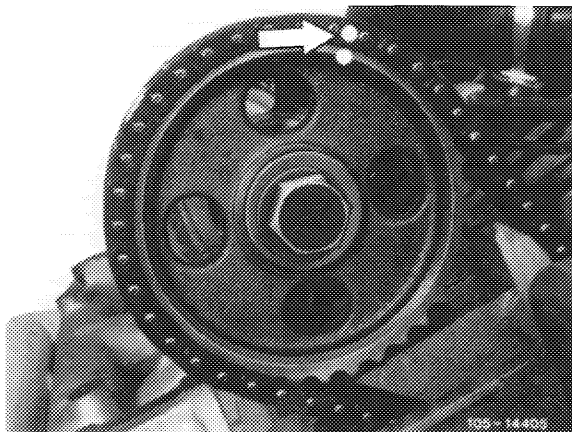

4 Unscrew closing plug (arrow).

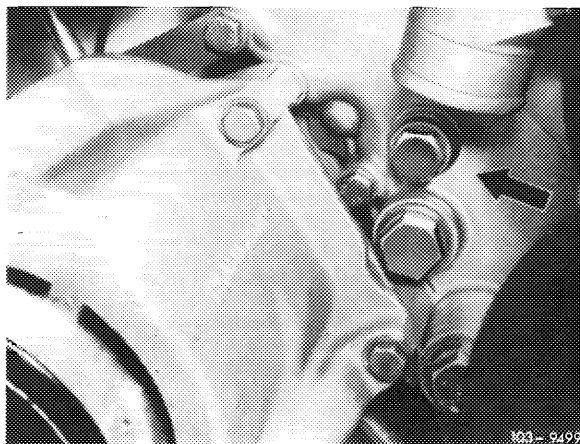

5 Pull out bearing bolt of tensioning rail with M 6 screw.

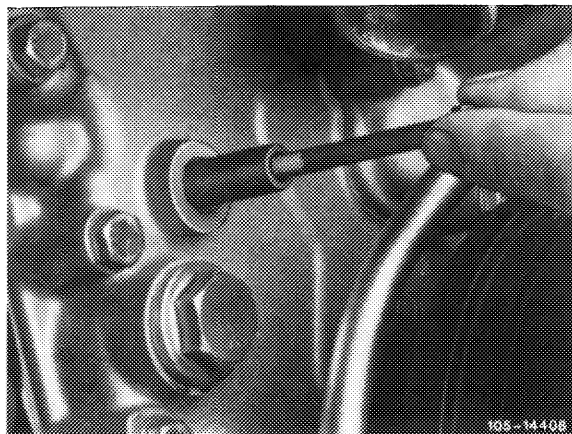

6 Remove tensioning rail.

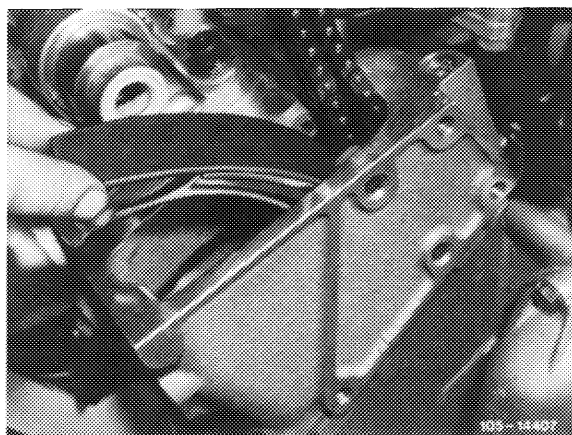

Installation

7 Introduce tensioning rails between timing housing cover and timing chain.

8 Introduce bearing bolt and knock-in up to stop.

9 Mount closing plug with sealing ring.

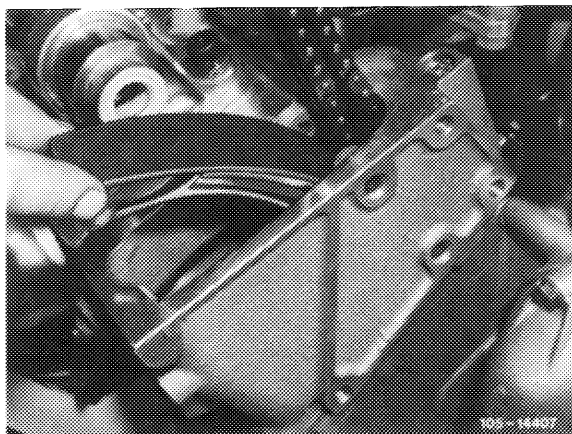

8 Mount camshaft sprocket in such a manner that the collar on camshaft sprocket (arrow) points in direction of camshaft.

9 For further installation proceed vice versa.

