

07.3-120 Testing fuel pressures and internal leakage

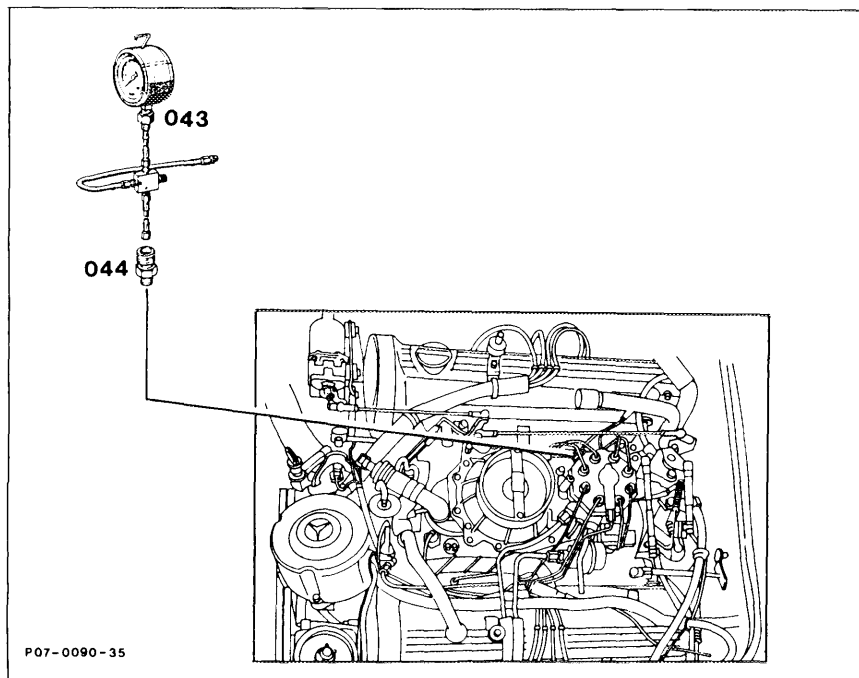

All fuel connections	check for leaks.
Ease of movement of air flow sensor plate and control plunger	check.
Pressure measuring device (043)	connect. Special tool 103 589 00 21 00.
Double union (044)	connect. Special tool 102 589 06 63 00.
System pressure	test.
Lower chamber pressure	test.
Acceleration enrichment	test.
Fuel distributor and fuel pump	test for leaks.

Fuel pressures in bar gauge pressure

System pressure when idling, engine cold or at normal operating temperature	6.2 – 6.4
---	-----------

Lower chamber pressure	engine at normal operating temperature	approx.	0.4 ¹⁾
	coolant temperature + 20 °C	approx.	0.5 ¹⁾
	during deceleration		6.2 – 6.4

¹⁾ Below system pressure measured previously.

Special tools

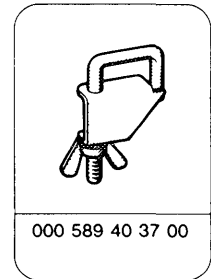
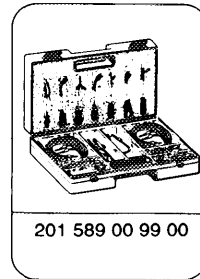
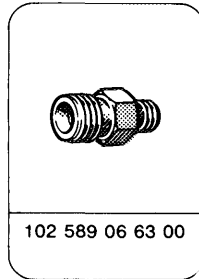
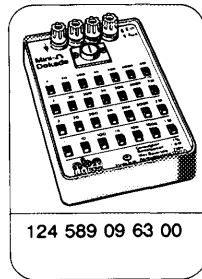
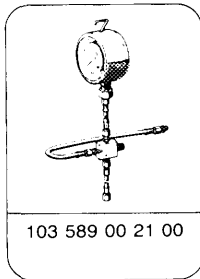

Commercial tester

Multimeter	e. g. Sun, DMM-5
------------	------------------

Note

The internal leakage test should only be performed if a complaint is received regarding starting engine when hot.

After switching off the engine, the fuel pressure must still be 3.0 bar gauge pressure after 30 minutes.

Visual inspection

- 1 Remove air filter.
- 2 Check all fuel connections for signs of leaks.

3 Check ease of movement of adjusting lever (1) with air flow sensor plate (4) in air flow sensor and of control plunger (2) in fuel distributor.

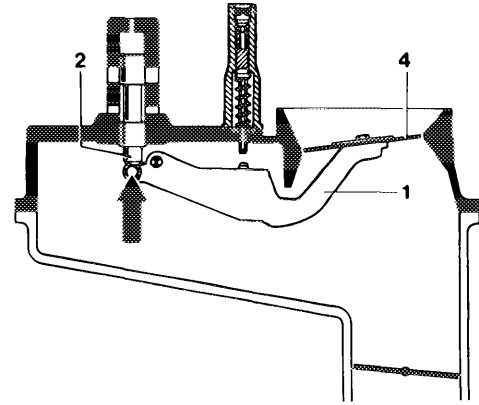

When performing this step, detach fuel pump relay (N16/4) of Model 126 in left side of component compartment and briefly jumper the two contacts 7 and 8 to build up pressure.

Model 126

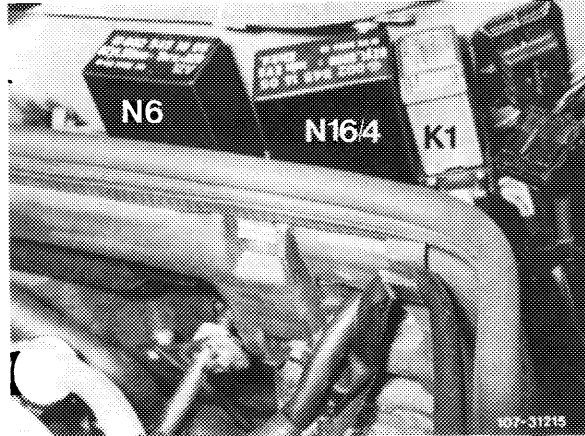

On Model 107, detach tail lamp wiring harness connector (X18) in left footwell below floor panel. Briefly connect terminal 2 to terminal 30 (cable connector next to overvoltage protection) to build up pressure.

Model 107

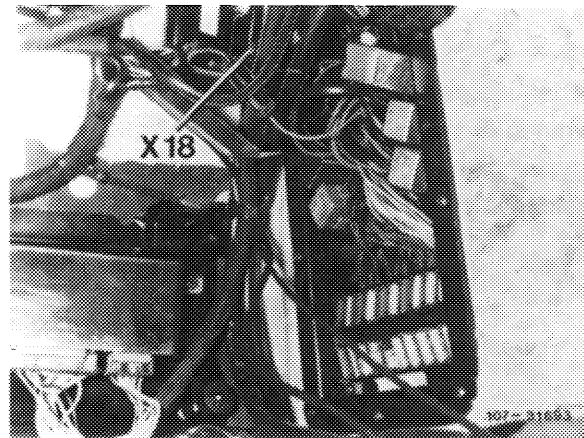

Press air flow sensor plate (4) down by hand. An even resistance must be felt over the entire travel. No resistance should be felt when making a rapid upward movement as the dampened control plunger loses contact with the adjusting lever (1). When performing a slow upward movement, the control plunger (2) must follow and maintain contact.

4 Check control plunger in fuel distributor for signs of leaks.

Press air flow sensor plate down fully for a short time and hold in this position. A slight leak quantity is permissible (illuminate, if necessary, with endoscope lamp).

Connect pressure measuring device.

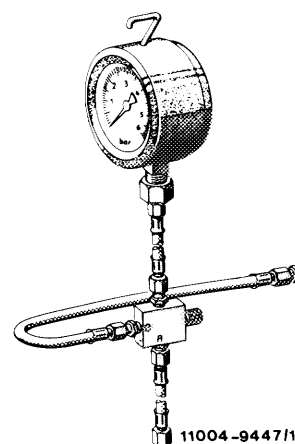

Connection A = Hose line to fuel distributor - lower chamber

Connection B = Hose line to fuel distributor - top chamber at starting valve

1 Unscrew plug (arrow) on bottom chamber fuel distributor.



When slackening plug, ensure that the open-end wrench does not press against the air flow sensor potentiometer, otherwise the potentiometer can be damaged.

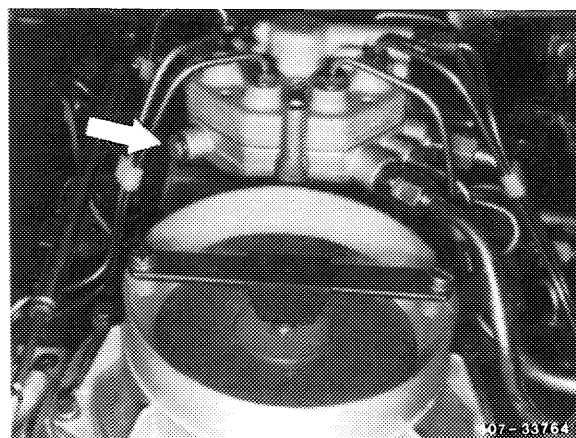

2 Connect hose line from connection "A" to bottom chamber.

Use double union M8 x 1/M12 x 1.5,
Special tool 102 589 06 63 00 to perform this step.

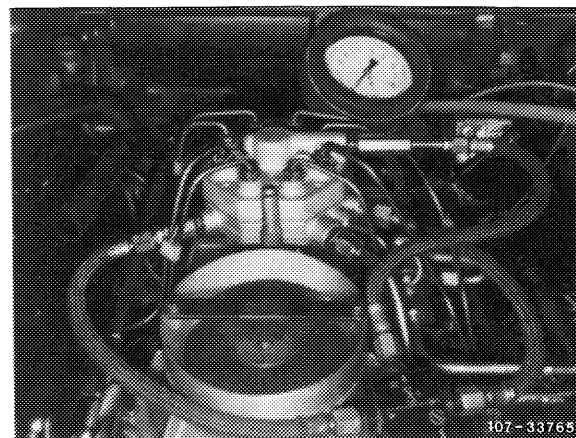

3 Unscrew fuel line for starting valve at fuel distributor.

4 Connect hose line from connection "B" to fuel distributor.

5 **Setting of valve screws:**

a) System pressure

Pressure measuring device = open valve screw.

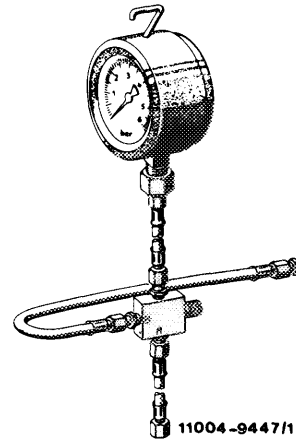

b) Lower chamber pressure

Pressure measuring device = close valve screw.

Testing

The system and lower chamber pressure must be tested when the engine is running.

Place pressure measuring device on cylinder head cover.

a) System pressure when engine cold or at normal operating temperature

- 1 Engine idling.
- 2 Take reading of system pressure.

Specification: 6.2 – 6.4 bar gauge pressure

- 3 If specified pressure is not reached or is exceeded:

Test fuel pump (07.3-130).

Renew diaphragm pressure regulator.

Check passage of fuel return line.

b) Lower chamber pressure when engine at normal operating temperature

- 4 Take reading of lower chamber pressure.

Specified pressure at normal operating temperature approx. 0.4 bar below system pressure.

If specified pressures are not reached:

Test electrohydraulic actuator (07.3-121).

c) Acceleration enrichment

"Engine cold" must be simulated for testing acceleration enrichment.

- 5 Valve screw closed.
- 6 Simulate "Engine cold" by connecting Ω decade 2.5 k Ω , corresponding to approx. + 20 °C, between coolant temperature sensor connecting cable and chassis ground.

7 Start engine. Specified pressure at + 20 °C approx. 0.5 bar below system pressure measured previously. Sharply increase engine speed to approx. 2500 rpm. When engine speed is increased, lower chamber pressure must drop.

If specification is not reached:

Test air flow sensor potentiometer (07.3-121).

Test current at actuator (07.3-121).

Testing fuel system for leaks

- 1 Switch off engine. Pressure in system drops below the opening pressure of the injection valves (approx. 3.4 bar gauge pressure).
- 2 If pressure drops immediately to 0 bar gauge pressure, renew check valve at fuel pump.
- 3 If pressure drops slowly, unscrew fuel return line (51) at diaphragm pressure regulator. No fuel should flow on out of the diaphragm pressure regulator (slight leak quantity is permissible).



If fuel flows out of fuel return line (51), fit plug to line.

- 4 Pinch leak line at fuel reservoir with clamp. If the pressure does not drop, renew fuel reservoir (07.3-270).

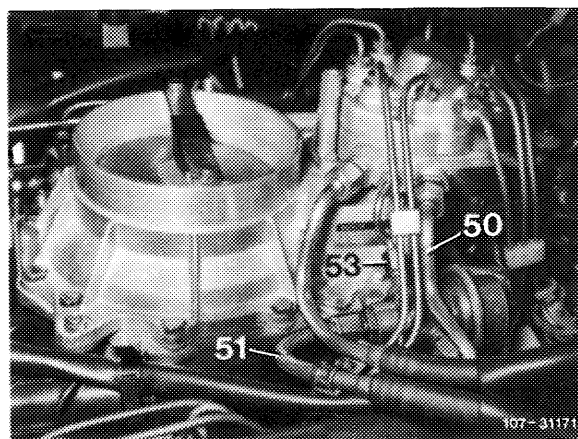

107-31171

- 5 If no leak is detected after performing internal leakage test, check starting valve for leaks. This is done by removing starting valve. Renew fuel distributor (07.3-205).
- 6 Disconnect pressure measuring device. Collect fuel with a rag.
- 7 Connect fuel lines, run engine once again and check all fuel connections for signs of leaks.
- 8 Install air filter.