

30-370 Testing cruise control (vehicles with ASR)

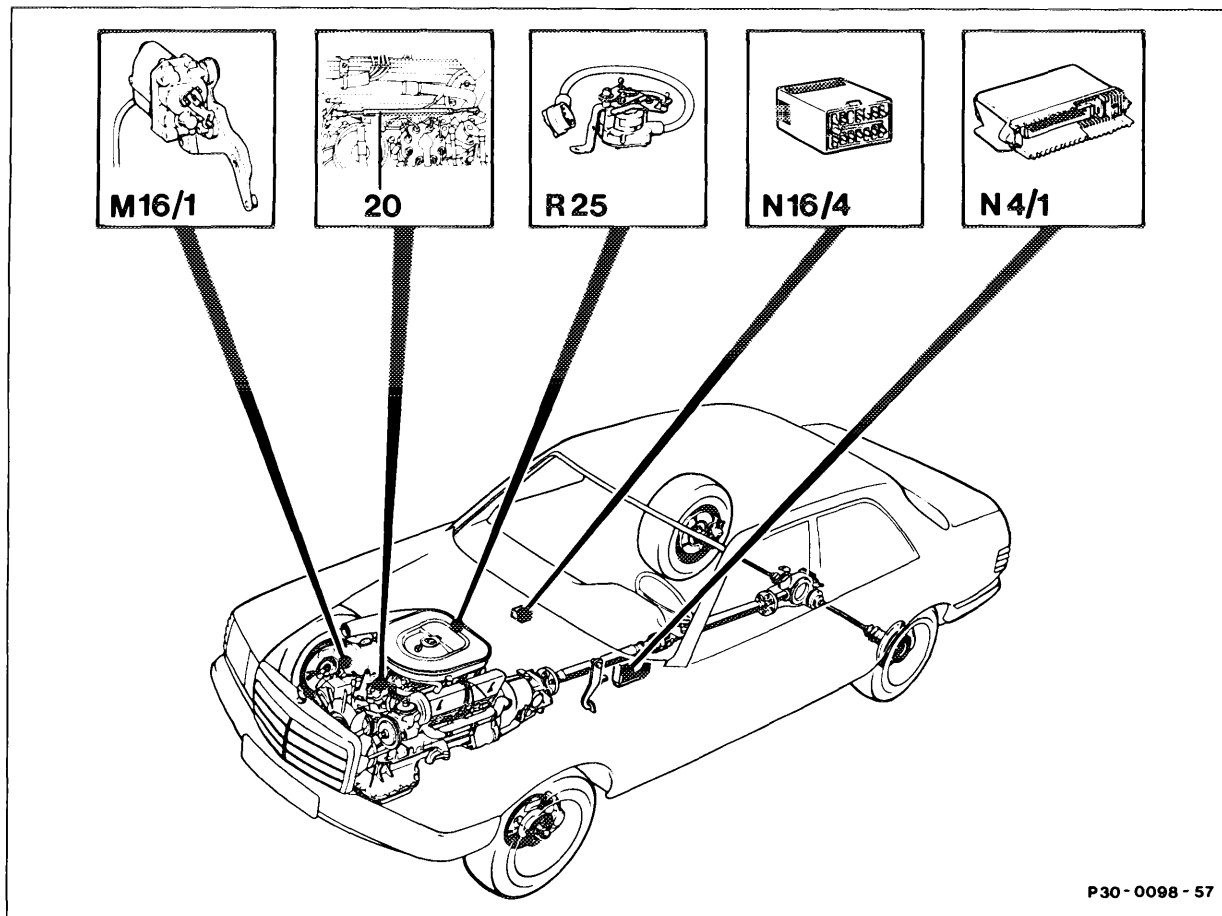

P30-0098-57

M16/1 Electronic accelerator actuator
N4/1 Electronic accelerator control unit
N16/4 Fuel pump relay with kickdown cut-out

R25 Accelerator pedal position sensor
20 Idle travel rod (redundancy rod)

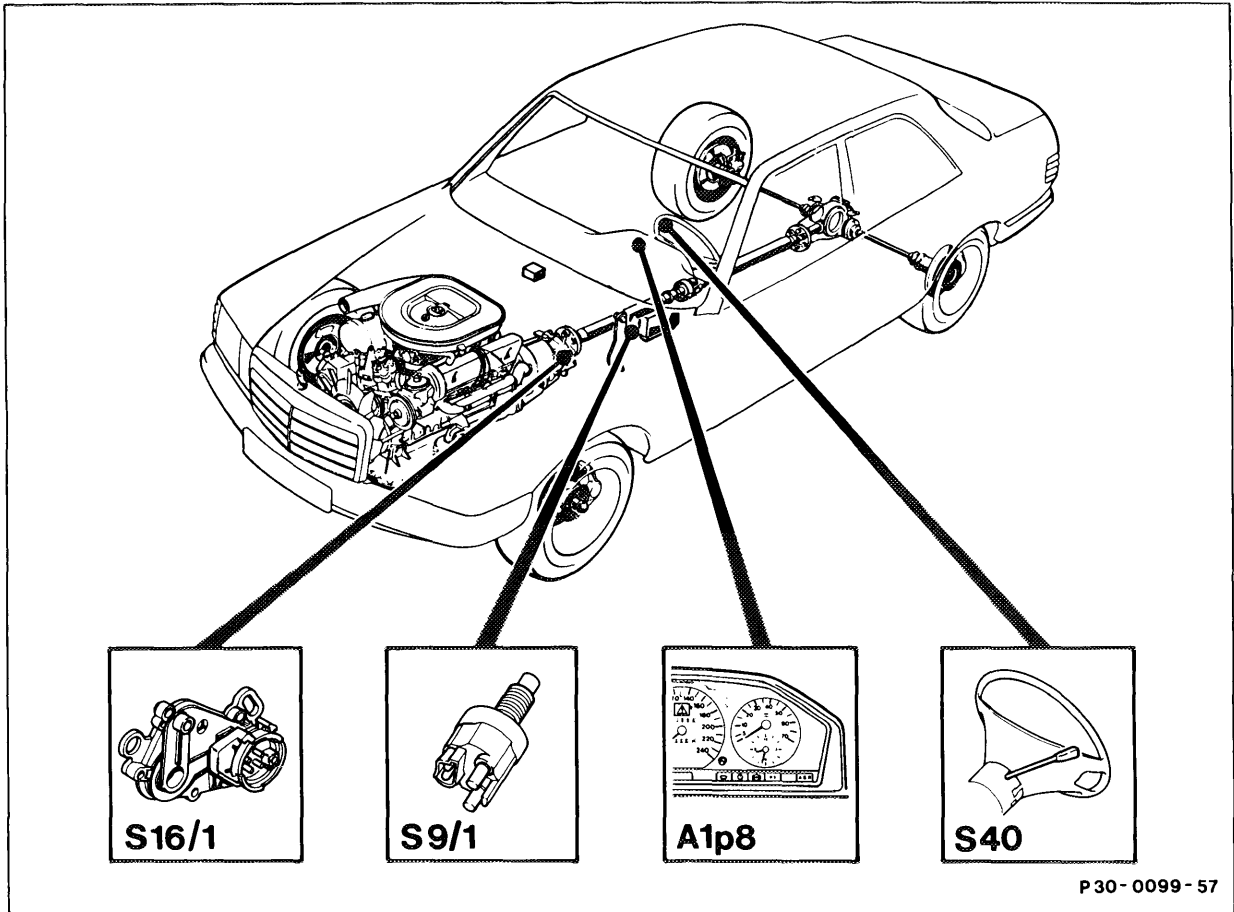

A1p8	Electronic speedometer	S16/1	Starter lockout and backup light switch
S9/1	Electronic accelerator control unit	S40	Cruise control switch

Special tools

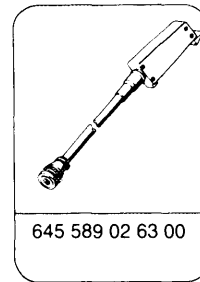
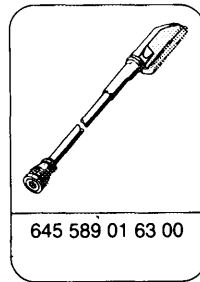
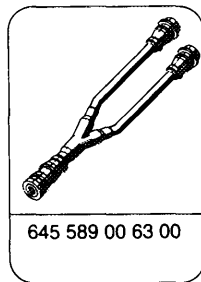
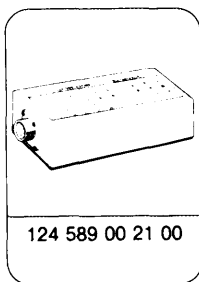

Commercial tools











Multimeter

e.g. Sun, DMM-5

Function generator

e.g. Sun, DTR-8416

Explanation of symbols

	Multimeter		Multimeter, resistance mode
	Contact box		Multimeter, D.C. voltage mode
	Function generator		Function generator, square-wave signal
	Battery		
	Contact		
	Connector		
	Jumper		
	Ground		

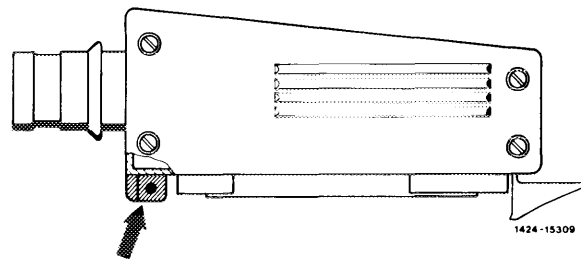

The stud (arrow) on the test cable
645 589 02 63 00 must be sawn off.

Pin assignment on electronic accelerator control unit

- 1 Voltage supply, terminal 15 unprotected
- 2 Voltage supply, terminal 15 unprotected
- 3 Electronic accelerator actuator (motor)
- 4 Electronic accelerator actuator (motor)
- 5 Reference potentiometer (ground)
- 6 Electronic accelerator actuator potentiometer (ground)
- 7 Do not create contact!
- 8 Engine 116, 117, 119: not assigned
Engine 103, 104: idle speed switching signal to CIS-E control unit
- 9 Reference potentiometer, voltage supply (+)
- 10 Not assigned
- 11 Battery ground (W10)
- 12 Electronic speedometer speed signal
- 13 Safety switch, reference potentiometer
- 14 Stop light switch
- 15 Reference potentiometer (wiper signal)
- 16 Cruise control switch (Decelerate, Set)
- 17 Not assigned
- 18 Cruise control switch (Resume)
- 19 Do not create contact!
- 20 Electronic accelerator actuator (motor)
- 21 Electronic accelerator actuator (motor)
- 22 Battery ground (W10)
- 23 Battery ground (W10)
- 24 Not assigned
- 25 Not assigned
- 26 Electronic accelerator actuator, potentiometer (voltage supply)
- 27 Not assigned
- 28 Electronic accelerator actuator, potentiometer (wiper signal)
- 29 Electronic accelerator actuator (safety switch)
- 30 Fuel pump relay, terminal 15, contact 9 or engine systems control unit, terminal 15u, contact 10
- 31 To ABS/ASR control unit (throttle valve actual value)
- 32 Cruise control switch (Accelerate, Set)
- 33 Starter lockout and backup light switch, driving stage "R"
- 34 From ABS/ASR control unit (throttle valve set value)
- 35 Cruise control switch (Off)

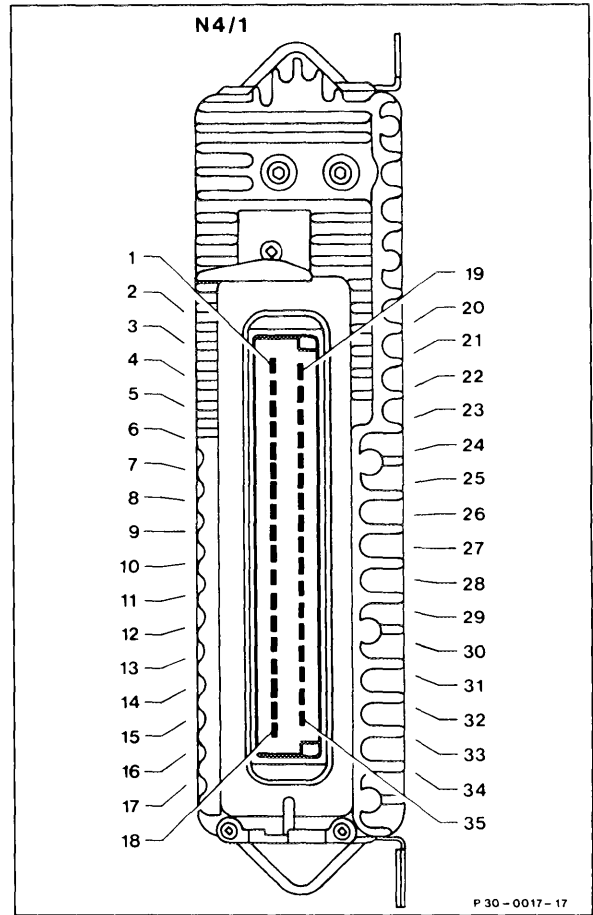

Connection diagram with multimeter for cruise control test routine

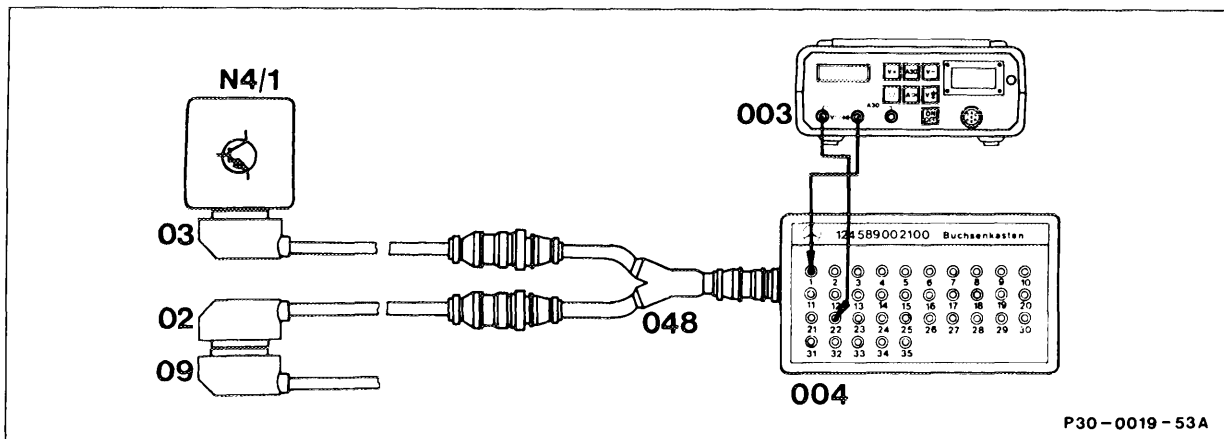

P30-0019-53A

02	Test cable	645 589 02 63 00	004	Contact box	124 589 00 21 00
03	Test cable	645 589 01 63 00	003	Multimeter	
09	Vehicle cable harness (electronic accelerator control unit)		N4/1	Electronic accelerator control unit	
048	Test cable	645 589 00 63 00			

Connection diagram with function generator for cruise control test routine

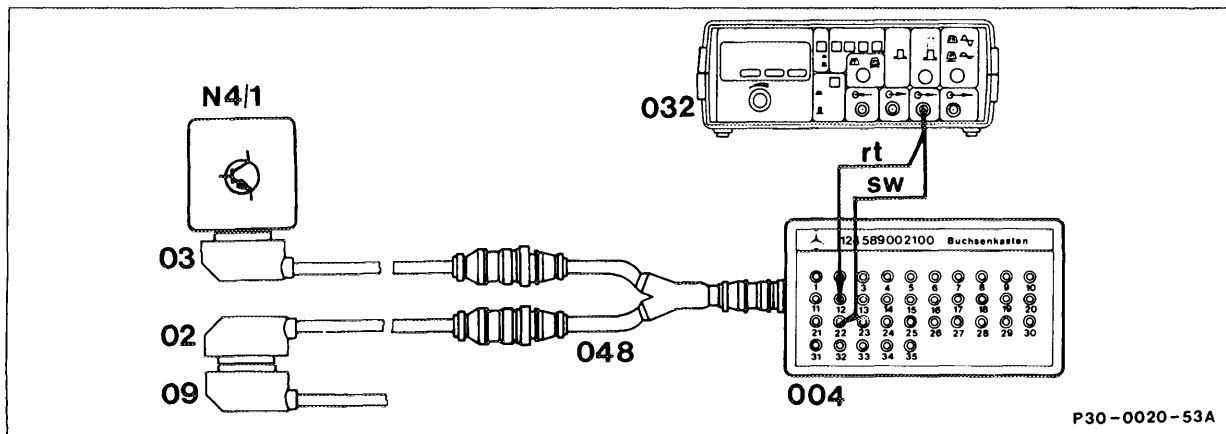







P30-0020-53A

02	Test cable	645 589 02 63 00	004	Contact box	124 589 00 21 00
03	Test cable	645 589 01 63 00	003	Multimeter	
09	Vehicle cable harness (electronic accelerator control unit)		N4/1	Electronic accelerator control unit	
048	Test cable	645 589 00 63 00			

Test requirement

Accelerator control adjusted and checked for ease of movement.

Battery voltage at least 11 Volts.

Test step	Test scope	Tester/ Test connection	Operation/ Requirement	Specifi- cation	Possible cause/Remedy
1.0	Cruise control switch (S40)		Ignition: ON Switch not operated	< 1 V	Test wiring for open/short circuit. Cruise control switch (S40) faulty
			Decelerate position Switch not operated	11–14 V < 1 V	
			Resume position Switch not operated	11–14 V < 1 V	
			Accelerate position Switch not operated	11–14 V < 1 V	
2.0	Stop light switch (S9/1)		Ignition: ON Brake pedal not operated	< 10 Ω	Test wiring for open/short circuit Stop light switch faulty
			Brake pedal operated	> 500 kΩ	
3.0	Speed signal		Ignition: ON Drive vehicle onto brake dynamometer or onto performance dynamometer (> 20 km/h)	> 1 V	Test wiring for open/short circuit Electronic speedometer faulty
4.0	Distance-related pulse number		Ignition: ON	11–14 V	Test wiring for open/short circuit Test wiring for correct assignment

Test step	Test scope	Tester/ Test connection	Operation/ Requirement	Specifi- cation	Possible cause/Remedy
5.0	Actuator function of cruise control	<p>N4/1</p>  <p>22 12</p>	<p>Withdraw instrument cluster (A1), detach connector "1"</p> <p>Connect frequency generator. Set $f > 150$ Hz $U = 5$ V Ignition: ON Accelerate position</p> <p>Decelerate position</p> <p>Off position</p> <p>Resume position</p> <p>Operate brake pedal</p>	<p>Actuator moves toward full load</p> <p>Actuator moves toward idle speed</p> <p>Actuator must move into idle speed position</p> <p>Actuator must move into specified position</p> <p>Actuator must move into idle position</p>	Electronic accelerator control unit (N4/1)