

## 30-365 Testing electronic accelerator

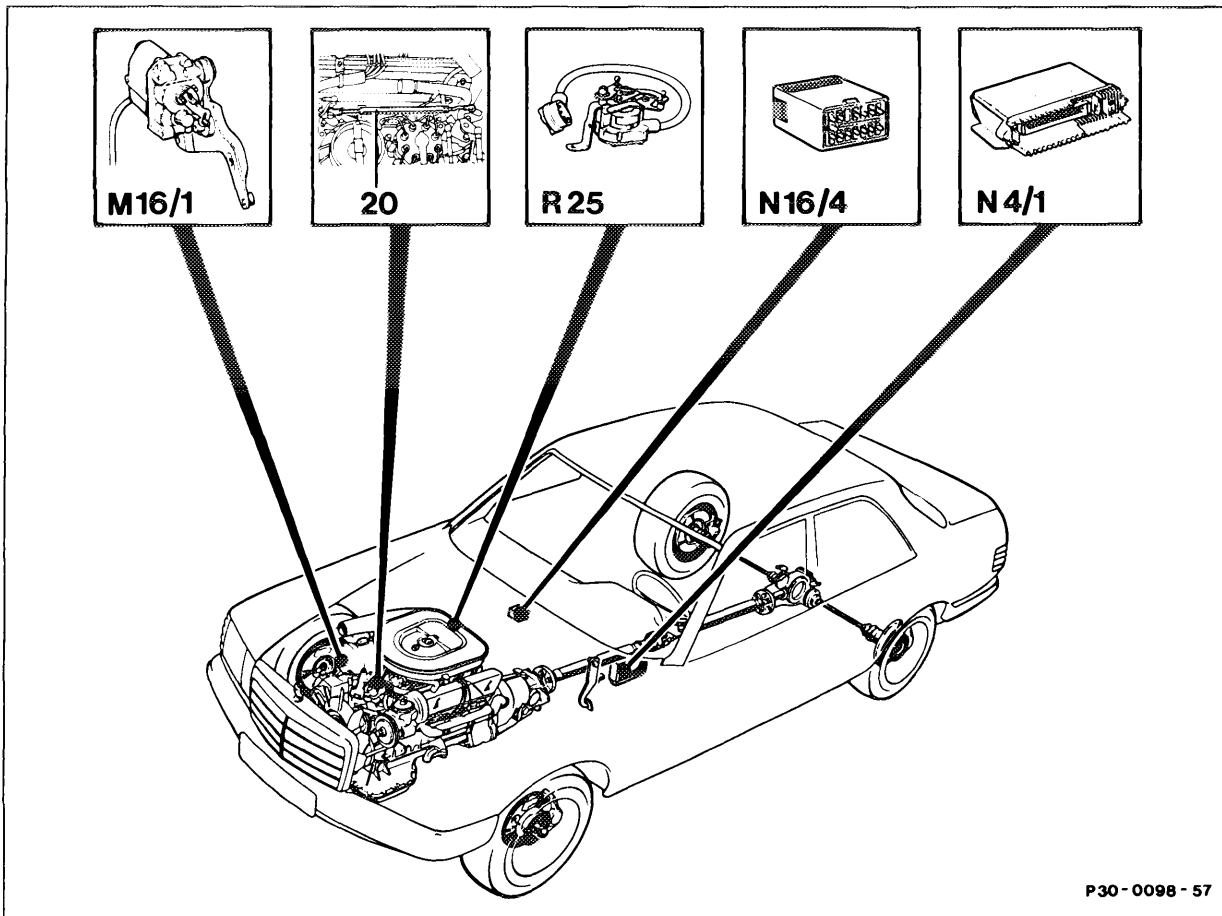

M16/1 Electronic accelerator actuator  
N4/1 Electronic accelerator control unit  
N16/4 Fuel pump relay with kickdown cut-out

R25 Accelerator pedal position sensor  
20 Idle travel rod (redundancy rod)

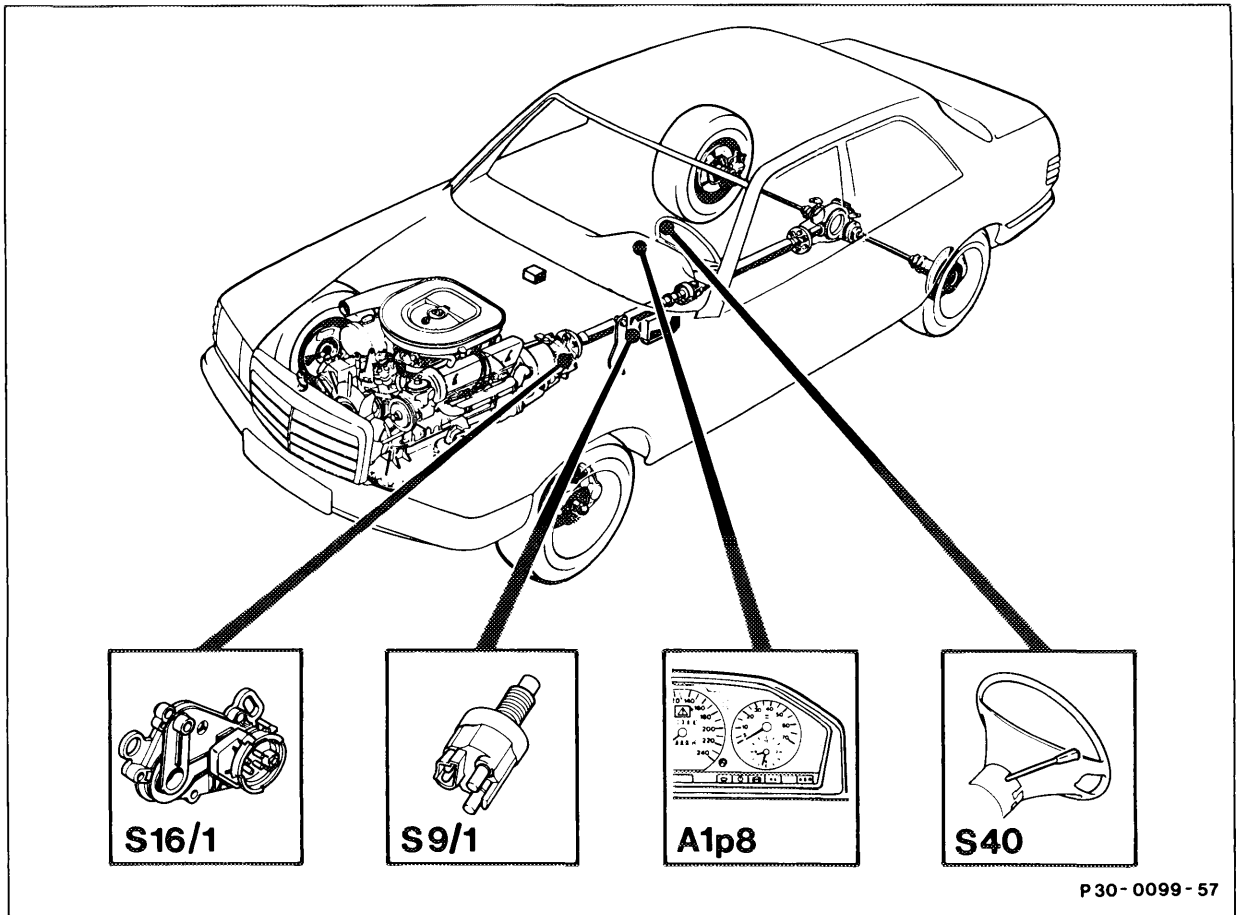

A1p8 Electronic speedometer  
 S9/1 Stop lamp switch (4MATIC/ASD)

S16/1 Starter lock-out/backup lamp switch  
 S40 Cruise control switch  
 V Decelerate/set  
 B Accelerate/set  
 SP Resume  
 A Off

### Special tools

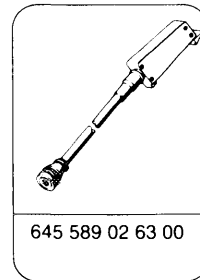
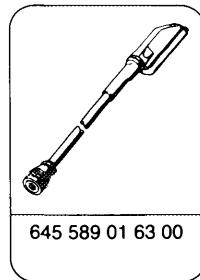
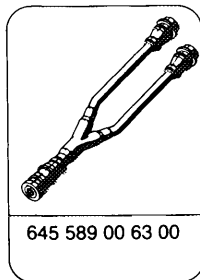
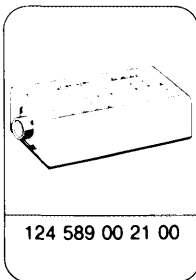







### Commercial tool

Multimeter

e.g. Sun, DMM-5

**Explanation of symbols**

-  Multimeter
  -  Contact box
  -  Battery
  -  Contact
  -  Plug
  -  Jumper
  -  Ground
-  Multimeter, resistance mode
  -  Multimeter, D.C. voltage mode

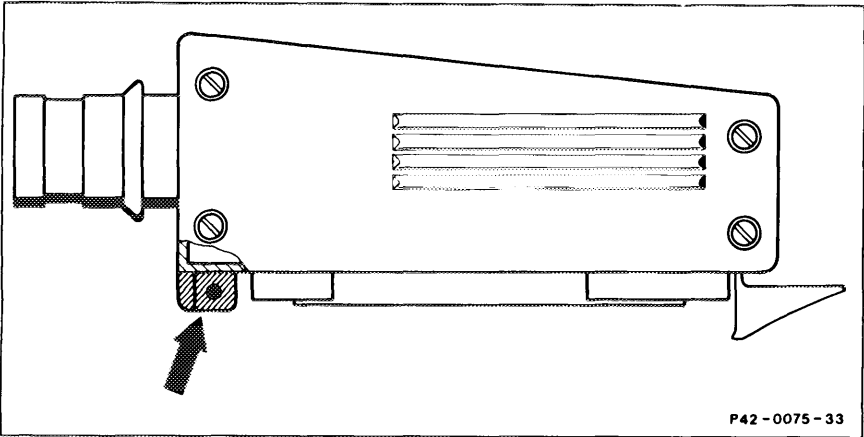

The stud (arrow) on the test cable  
645 589 02 63 00 must be sawn off.

Pin assignment on electronic accelerator control unit

- 1 Voltage supply, terminal 15 unprotected
- 2 Voltage supply, terminal 15 unprotected
- 3 Electronic accelerator actuator (motor)
- 4 Electronic accelerator actuator (motor)
- 5 Reference potentiometer (ground)
- 6 Electronic accelerator actuator potentiometer (ground)
- 7 Do not create contact!
- 8 Engine 116, 117, 119: not assigned  
Engine 103, 104: idle speed switching signal to CIS-E control unit
- 9 Reference potentiometer, voltage supply ( + )
- 10 Not assigned
- 11 Battery ground (W10)
- 12 Electronic speedometer speed signal
- 13 Safety switch, reference potentiometer
- 14 Stop light switch
- 15 Reference potentiometer (wiper signal)
- 16 Cruise control switch (Decelerate, Set)
- 17 Not assigned
- 18 Cruise control switch (Resume)
- 19 Do not create contact!
- 20 Electronic accelerator actuator (motor)
- 21 Electronic accelerator actuator (motor)
- 22 Battery ground (W10)
- 23 Battery ground (W10)
- 24 Not assigned
- 25 Not assigned
- 26 Electronic accelerator actuator, potentiometer (voltage supply)
- 27 Not assigned
- 28 Electronic accelerator actuator, potentiometer (wiper signal)
- 29 Electronic accelerator actuator (safety switch)
- 30 Fuel pump relay, terminal 15, contact 9 or engine systems control unit, terminal 15u, contact 10
- 31 To ABS/ASR control unit (throttle valve actual value)
- 32 Cruise control switch (Accelerate, Set)
- 33 Starter lockout and backup light switch, driving stage "R"
- 34 From ABS/ASR control unit (throttle valve set value)
- 35 Cruise control switch (Off)

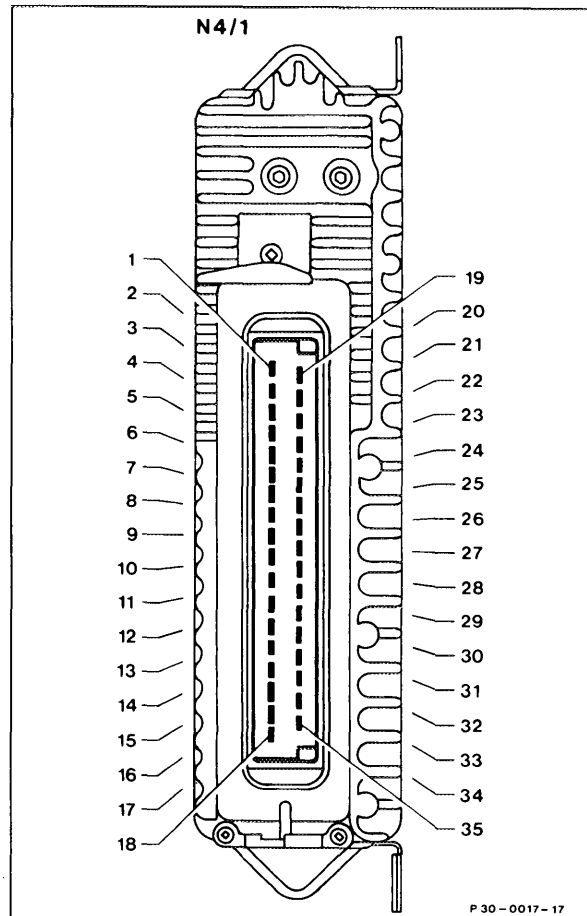

P 30 - 0017 - 17

Connection diagram with multimeter for electronic accelerator test routine

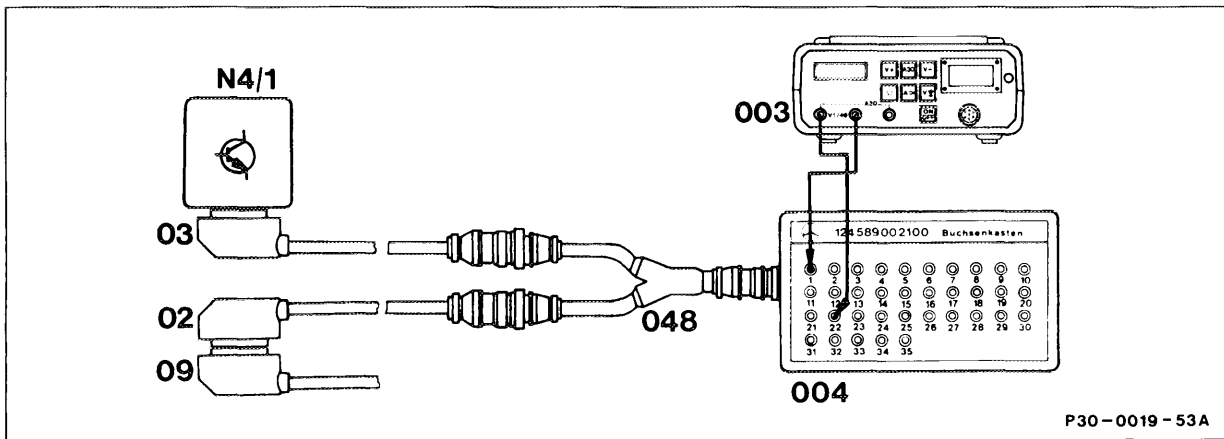

02	Test cable	645 589 02 63 00	003	Multimeter	
03	Test cable	645 589 03 63 00	004	Contact box	124 589 00 21 00
09	Vehicle wiring harness (electronic accelerator control unit)		048	Test cable	645 589 00 63 00
			N4/1	Electronic accelerator control unit	

Connection diagram with 2 multimeters for electronic accelerator test routine

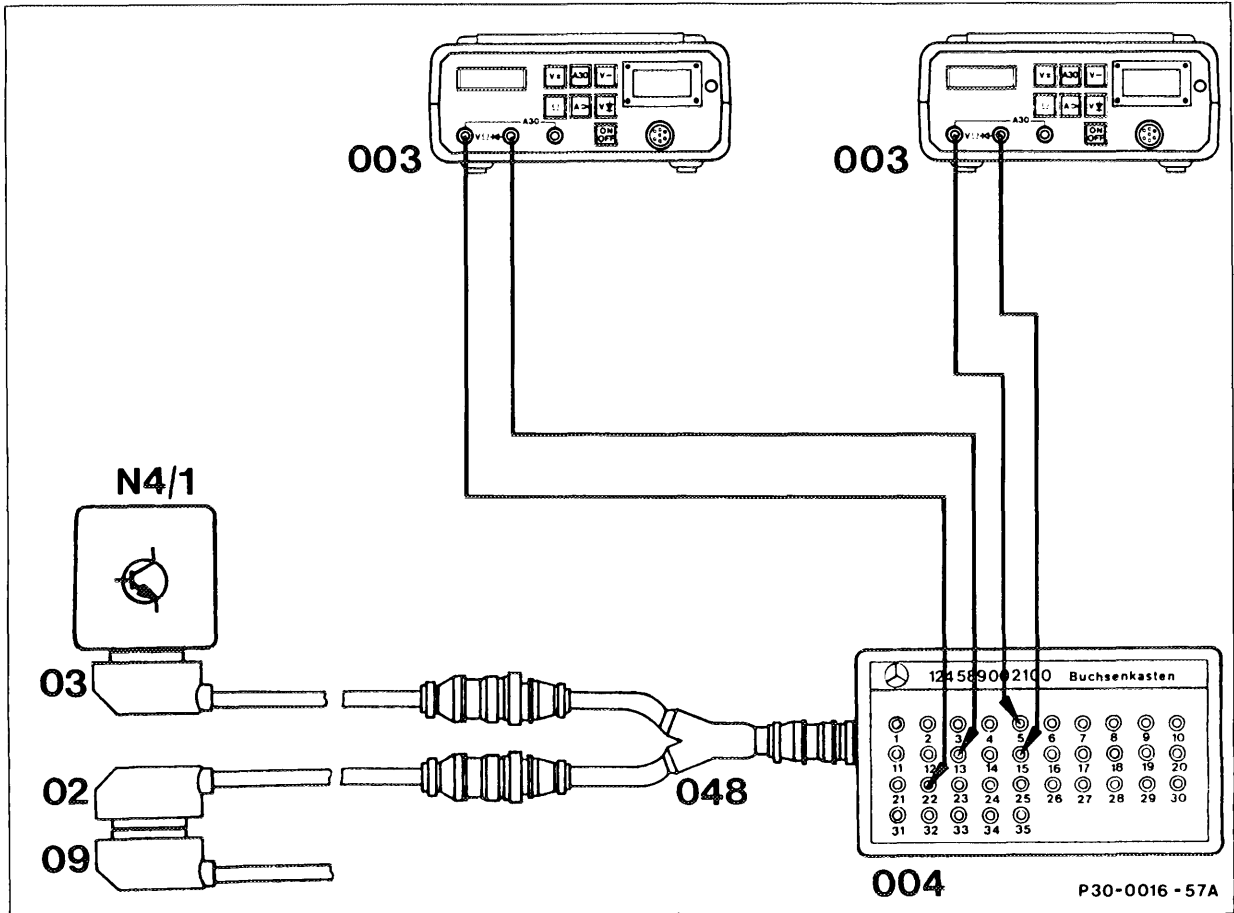







02 Test cable 645 589 02 63 00  
 03 Test cable 645 589 03 63 00  
 09 Vehicle wiring harness (electronic accelerator control unit)

003 Multimeter  
 004 Contact box 124 589 00 21 00  
 048 Test cable 645 589 00 63 00  
 N4/1 Electronic accelerator control unit





**Test requirement**











Accelerator control linkage correctly set and checked for ease of movement (30-305).  
 Battery voltage at least 11 Volts.

Test step	Test scope	Tester/ Test connection	Operation/ Requirement	Specifi- cation	Possible cause/Remedy
1.0	Ground point at electronic accelerator control unit (N4/1)	 22   23	-	11-14 V  11-14 V	Battery ground connection (G1) loose, open circuit  Battery ground connection (G1) loose, open circuit
2.0	Power supply of electronic accelerator control unit (N4/1)	 22 1   22 2	Ignition: <b>ON</b>	11-14 V  11-14 V	Wiring connection (N4/1) → (F1) Fuse No. 6  Wiring connection (N4/1) → (F1) Fuse No. 6
3.0	Power supply of reference potentiometer (R25)	 5 9	Ignition: <b>ON</b> Note voltage reading	6,8-7,6 V  Initial value "A" for table of "Reference potentiometer (R25) voltage levels"	Check open circuit, see test step 7.0 Reference potentiometer (R25) Control unit (N4/1)
3.1	Signal of reference potentiometer (R25)	 5 15	Ignition: <b>ON</b> Idle position "a" Operate accelerator Full throttle position "b" Kickdown "c"	Voltage levels, see table "Reference potentiometer (R25) voltage levels" column a, b, c	Test wiring for open circuit/short-circuit, see test step 7.0. If specification not reached, see test step 3.3

Test step	Test scope	Tester/ Test connection	Operation/ Requirement	Specifi- cation	Possible cause/Remedy
3.2	Reference potentiometer (R25) switch point safety switch	<p>22  13</p> <p>5  15</p> <p>Second multimeter to contact box</p>	<p>Ignition: <b>ON</b> Idle speed position</p> <p>Slowly deflect accelerator pedal until shift point occurs</p> <p>Note voltage reading at shift point</p>	<p>&lt; 1 V</p> <p>11–14 V</p> <p>Voltage levels, see table "Reference potentiometer (R25) voltage levels" column "d"</p>	<p>Test wiring for open circuit/short-circuit, see test step 7.0</p> <p>–</p> <p>Reference potentiometer faulty</p>
3.3	Reference potentiometer (R25)	<p>1  9</p> <p>5  22</p> <p>5  15</p>	<p>Ignition: <b>OFF</b> Detach electronic accelerator control unit connector.</p> <p>Ignition: <b>ON</b> Deflect accelerator pedal as far as full throttle stop</p>	<p>Voltage must rise to &gt; 9 V</p>	<p>Reference potentiometer faulty</p>
4.0	Actuator (M16/1) power supply potentiometer	<p>6  26</p>	<p>Ignition: <b>ON</b> Note voltage reading</p>	<p>6.8–7.6 V Initial value "B" for table "Actuator (M16/1) voltage levels"</p>	<p>Test wiring for open circuit/short-circuit, see test step 8.0. Electronic accelerator control unit faulty</p>



Test step	Test scope	Tester/ Test connection	Operation/ Requirement	Specifi- cation	Possible cause/Remedy
4.1	Actuator (M16/1) potentiometer signal	6  28	Ignition: <b>ON</b> Idle position "e" Depress accelerator Full throttle position "f"	Voltage levels, see table "Actuator (M16/1) voltage levels" column "e, f"	Test wiring for open circuit/short-circuit, see test step 8.0. If specification is not reached, see test step 4.4
4.2	Actuator (M16/1) switch point safety switch	22  29	Ignition: <b>ON</b> Idle position  Slowly deflect accelerator pedal until switch point occurs	11-14 V  < 1 V	Test wiring for open circuit/short-circuit, see test step 8.0  Actuator faulty
		6  28 Second multimeter to contact box	Note voltage reading at switch point	Voltage levels, see table "Actuator (M16/1) voltage levels" column "g"	
4.3	Actuator (M16/1) D.C.	N4/1  3	Ignition: <b>ON</b> Press accelerator control linkage, connecting rod (21, engine 116, 117 ill. page 119) toward idle speed position	Voltage must rise (+ value)	Test wiring for open circuit, see test step 4.5. If specifications are not reached, see test step 4.4

Test step	Test scope	Tester/ Test connection	Operation/ Requirement	Specifi- cation	Possible cause/Remedy
4.4	Actuator (M16/1)	 1  26 6  22 6  28	Ignition: <b>OFF</b> Detach electronic accelerator control unit connector. Ignition: <b>ON</b> Deflect accelerator pedal as far as full throttle stop	Voltage must drop to < 7 V	Actuator faulty
4.5	Actuator (M16/1)	 21  3	Ignition: <b>OFF</b> Detach electronic accelerator control unit connector. Ignition: <b>ON</b> Deflect accelerator pedal	< 10 Ω	Actuator faulty Electronic accelerator control unit faulty
5.0	Backup light switch (S16/1)	 22  33	Ignition: <b>ON</b> Selector lever position "P"  Selector lever position "R"  Part throttle and shift selector lever from "P" to "R" and "R" to "P"	< 1 V  11–14 V	Test wiring for open circuit/short-circuit  Electronic accelerator control unit faulty
6.0	Fuel pump relay (N16.4)	 22  30	Start engine Idle speed  Detach test cable 645 589 02 63 00 upstream of Y connector	11–14 V  Engine must cut out	Test wiring for open circuit/short-circuit   Contact 30 is not short circuit proof to ground. Electronic accelerator control unit faulty. Test wiring for correct assignment.

Test step	Test scope	Tester/ Test connection	Operation/ Requirement	Specifi- cation	Possible cause/Remedy
7.0	Test wiring between reference potentiometer connector (R25x1) and control unit connector (N4/1)	<p style="text-align: center;">R25x1</p> <p style="text-align: center;">← Ω →</p> <p>1 ← Ω → 2</p> <p>1 ← Ω → 3</p> <p>1 ← Ω → 6</p> <p>1 ← Ω → 7</p> <p>2 ← Ω → 3</p> <p>2 ← Ω → 6</p> <p>2 ← Ω → 7</p> <p>3 ← Ω → 6</p> <p>3 ← Ω → 7</p> <p>6 ← Ω → 7</p>	Ignition: <b>OFF</b> Detach connector at electronic accelerator control unit. Separate plug connections at reference potentiometer and actuator	> 500 kΩ	at < 500 kΩ renew wiring harness
8.0	Test wiring between actuator connector (M16/1) and control unit connector (N4/1)	<p style="text-align: center;">M16/1x</p> <p style="text-align: center;">← Ω →</p> <p>1 ← Ω → 2</p> <p>1 ← Ω → 3</p> <p>1 ← Ω → 4</p> <p>1 ← Ω → 5</p> <p>1 ← Ω → 6</p> <p>1 ← Ω → 7</p> <p>2 ← Ω → 3</p> <p>2 ← Ω → 4</p> <p>2 ← Ω → 5</p> <p>2 ← Ω → 6</p> <p>2 ← Ω → 7</p> <p>3 ← Ω → 4</p> <p>3 ← Ω → 5</p> <p>3 ← Ω → 6</p> <p>3 ← Ω → 7</p> <p>4 ← Ω → 5</p> <p>4 ← Ω → 6</p> <p>4 ← Ω → 7</p> <p>5 ← Ω → 6</p> <p>5 ← Ω → 7</p> <p>6 ← Ω → 7</p>	Ignition: <b>OFF</b> Detach connector at electronic accelerator control unit. Separate plug connections at reference potentiometer and actuator	> 500 kΩ	at < 500 kΩ renew wiring harness

**Voltage levels electronic accelerator reference potentiometer (R25)**

"A" Potentiometer voltage supply V	"a" Voltage in idle speed position V	"b" Voltage in full throttle position V	"c" Voltage at kickdown V	"d" Voltage at safety switch switch point V
6.8	0.50-0.56	5.86-6.22	5.86-6.37	0.86-1.13
6.9	0.51-0.57	5.95-6.32	5.95-6.46	0.87-1.14
7.0	0.52-0.58	6.04-6.41	6.04-6.55	0.89-1.16
7.1	0.53-0.58	6.13-6.50	6.13-6.64	0.90-1.17
7.2	0.53-0.59	6.21-6.59	6.21-6.74	0.91-1.19
7.3	0.54-0.60	6.30-6.68	6.30-6.83	0.92-1.21
7.4	0.55-0.61	6.39-6.77	6.37-6.92	0.94-1.22
7.5	0.56-0.62	6.48-6.86	6.48-7.01	0.95-1.24
7.6	0.56-0.63	6.56-6.95	6.56-7.11	0.96-1.26

**Voltage levels electronic accelerator actuator (M16/1)**

"B" Potentiometer voltage supply V	"e" Voltage in idle position V	"f" Voltage in full throttle position V	"g" Voltage at safety switch switch point V
6.8	6.05-6.19	0.61-0.75	5.35-5.68
6.9	6.14-6.28	0.62-0.76	5.43-5.76
7.0	6.23-6.37	0.63-0.77	5.51-5.89
7.1	6.32-0.46	0.64-0.78	5.59-5.93
7.2	6.41-6.55	0.65-0.79	5.67-6.01
7.3	6.50-6.64	0.66-0.80	5.75-6.10
7.4	6.59-6.73	0.67-0.81	5.82-6.18
7.5	6.68-6.83	0.68-0.83	5.90-6.26
7.6	6.76-6.92	0.69-0.84	5.98-6.35

# Wiring diagram

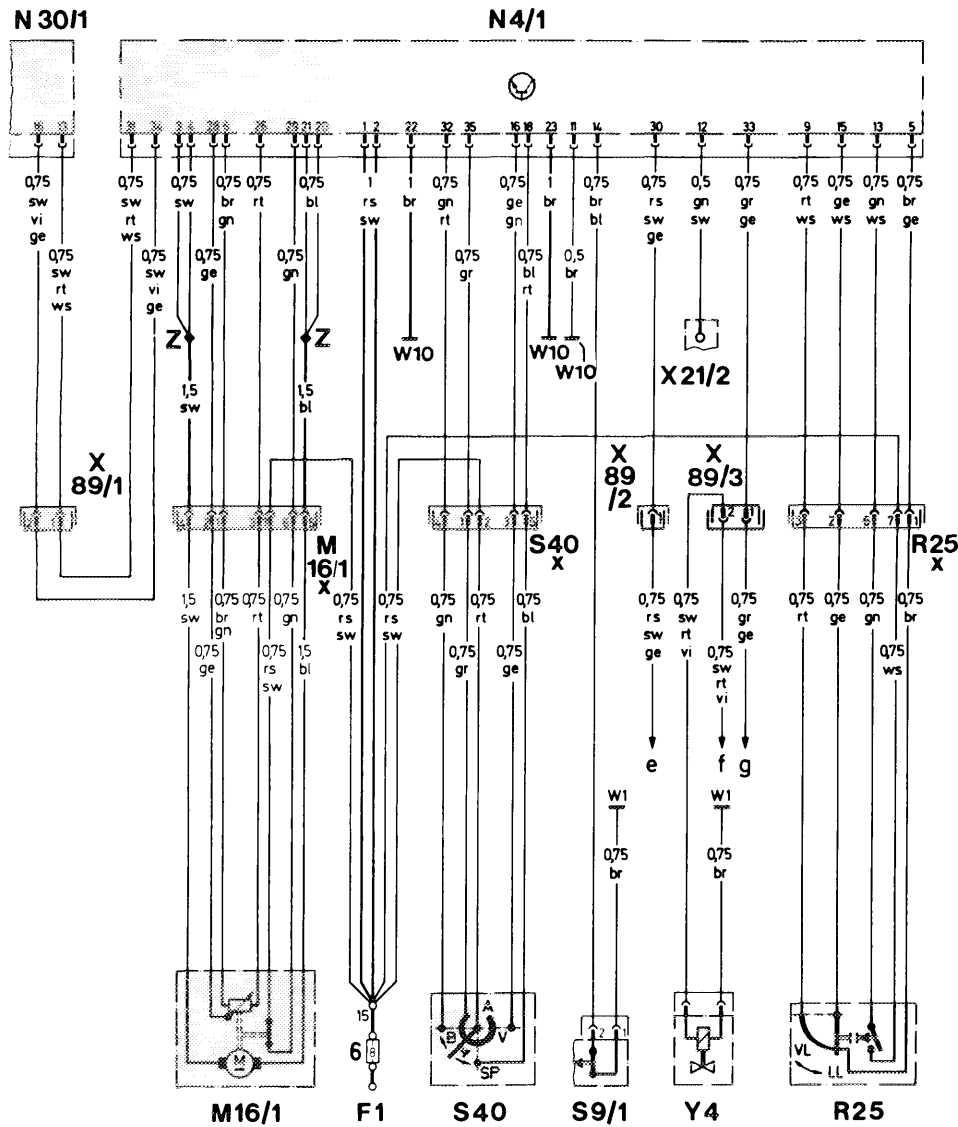

P30-0087-59

F1	Fuse and relay box	X89/1	Connector, electronic accelerator control unit/ASR (2-pole)
G1	Battery	X89/2	Connector, electronic accelerator control unit/engine harness (2-pole)
M16x1	Connector, cruise control actuator	X89/3	Connector, electronic accelerator control unit/automatic transmission (2-pole)
M16/1	Electronic accelerator actuator	Y4	Switchover valve (transmission mode)
N4/1	Electronic accelerator control unit	Z	Connector sleeve (solder joint in harness)
N30/1	ABS/ASR control unit	e	Fuel pump relay, contact 9, terminal 15
R25	Accelerator pedal position sensor	f	Economy mode switch, contact 2
R25x1	Connector, accelerator pedal position sensor	g	Starter lockout and backup light switch, contact 4
S9/1	Stop lamp switch (4MATIC/ASD)		
S40	Cruise control switch		
	V Decelerate/set		
	B Accelerate/set		
	SP Resume		
	A Off		
S40x1	Connector, cruise control switch		
W10	Ground, battery		
X21/2	Terminal block, stop lamp switch/electronic speedometer		

### Arrangement

The electronic accelerator control unit (N4/1) is located below the instrument panel, above the pedals.

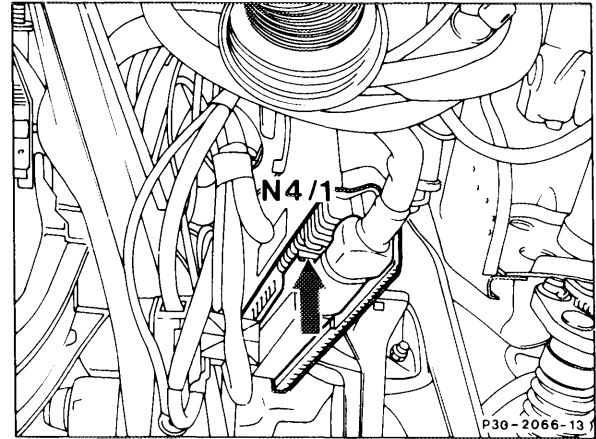

The cruise control actuator connector (M16x1) is located ahead of the expansion tank (cover removed).

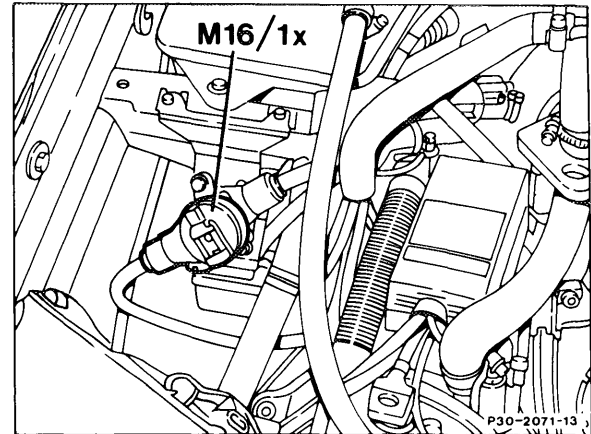

The electronic accelerator reference potentiometer connector (R25x1) is located next to the expansion tank (cover removed).

