

Special tools

Tester for cooling system

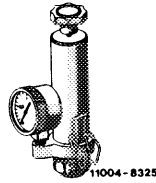

001 589 48 21 00

Radiator cap with hose
for tester

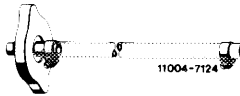

605 589 00 25 00

Conventional tool

7 mm hex. socket insert on flexible shaft
for hose clamps with worm drive

e.g. Hazet, D-5630 Remscheid
Order No. 426-7

Note

Since light-alloy radiators with plastic coolant tanks cannot be repaired by soldering, a sealing compound has been developed for this purpose.

This compound can also be used to seal heavy metal radiators (non-ferrous metal radiators).

The sealing compound is a product on a silicone-rubber base, which remains permanently elastic in its final condition. Temperature stability from -50°C to $+200^{\circ}\text{C}$.

Because of the varying accessibility to the radiator (e.g. in core more difficult than on coolant tank), sealing compound is available in a diluted and a non-diluted condition.

The varying sealing compound versions and the priming fluid are combined in a repair kit, part No. 123 989 00 20.

Designation	Purpose
Priming fluid	Preparation of the adhesive area
Sealing compound non-diluted	For sealing easily accessible areas
Sealing compound diluted	For sealing areas with poor access (e.g. laterally at cooling tubes)

Sealing compound and priming fluid have a shelf life of approx. 1 year if they are always closed air-tight after use.

Turbid priming fluid should no longer be used.

The following parts or areas in the cooling system can be sealed with sealing compound:

- a) Plastic coolant tanks (3 and 4).
- b) Heavy-metal coolant tanks (holes up to 1.5 mm dia.).
- c) Light-alloy and heavy-metal cooling tubes (6).
- d) Tube plate (2).
- e) Bead flange (connection between radiator core and coolant tank).
- f) Heat exchanger of heating system.

- | | |
|-----------------------|-----------------|
| 1 Radiator core | 5 Gasket |
| 2 Tube base | 6 Cooling tubes |
| 3 Coolant tank top | 7 Gills |
| 4 Coolant tank bottom | |

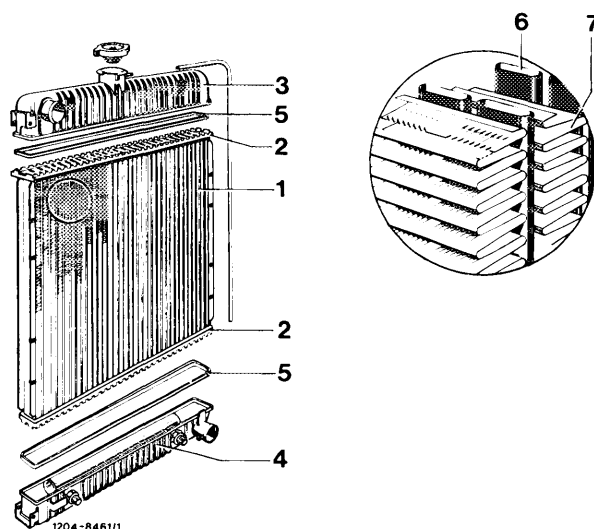

Damaged parts on the coolant tanks which are subject to higher loads, such as torn or broken fastening brackets, cracks in the fillet to the connections, breaks and very long or large cracks on the surface should not be repaired, since the sealing compound can take only a very low load.

Plastic coolant tanks of Behr radiators can be exchanged by means of special tools or fixtures in the Behr radiator repair shops or in Inter-Radia service stations. If required, contact the nearest Behr repair shop or Inter-Radia service station for this purpose and find out whether such repairs are possible.

If this is not possible, replace the radiator.

On heavy-metal radiators with plastic coolant tanks, soldering on the core may be performed only up to a distance of 20 mm from the coolant tank, as otherwise the high soldering temperature will damage the gasket (5) and the coolant tank (3 or 4). Leaks which are closer to the coolant tank should be sealed with sealing compound only.

If the leaking area cannot be clearly identified in the installed condition, the radiator need not be removed. In this case it will be sufficient to drain the coolant and to pressure-test the cooling system after sealing.

When handling priming fluid and sealing compound, observe the following:

The priming fluid is easily inflammable (observe safety regulations for dangerous materials class A 1).

Acetic acid will be released until the linking (setting) of the sealing compound has been completed. For this reason, any skin contact should be avoided. Clean affected areas immediately with water and soap. Rinse eyes with water and see a doctor if necessary.

Sealing

- 1 If the leaking area cannot be located properly in the installed condition, remove the radiator (20–420) and unscrew the air oil cooler from the radiator.
- 2 Clean the radiator.
- 3 Close the hose connections with self-made closing caps.

Required parts for upper hose connection:

- 15 2 clamps L 40–50, part No. 916026 040000
- 16 Coolant hose, part No. 126 501 02 82
- 17 Reducer made of two pipes
- A 38 mm dia.
- B 39 mm dia.
- C 12 mm dia.

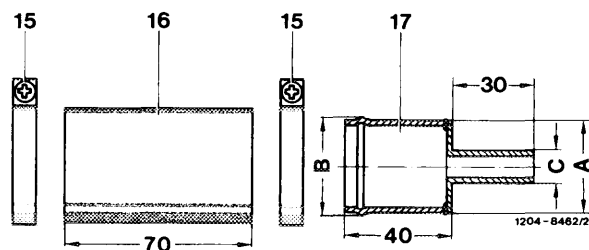

Required parts for lower hose connection:

- 18 2 clamps L 40–50, part No. 916026 040000
- 19 Coolant hose, part No. 126 501 02 82
- 20 Cap made from pipe
- A 38 mm dia.
- B 39 mm dia.

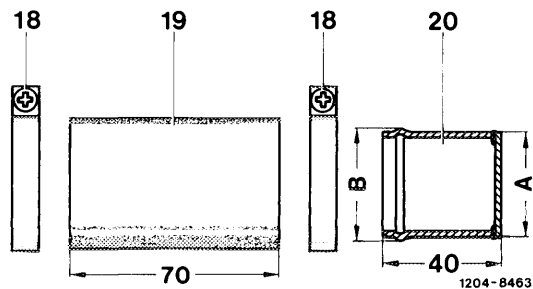

Close overflow connection on upper coolant tank.

Required parts for inlet from expansion tank:

- 18 2 clamps L 28—35, part No. 916026 028000
- 19 Coolant hose, part No. 126 501 10 82
- 20 Cap made from pipe
- A 21 mm dia.
- B 22 mm dia.

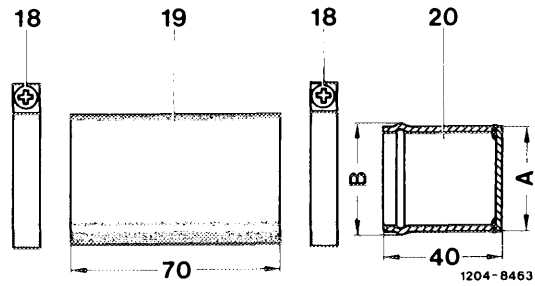

4 Close connections of gear oil cooler on lower coolant tank with plastic caps or plugs from used oil cooler lines. For this purpose, saw off oil cooler lines directly behind nipple and close with solder.

5 Connect tester to radiator.

For leak test, pull hose from radiator cap and attach to reducer on the upper hose connection of the radiator.

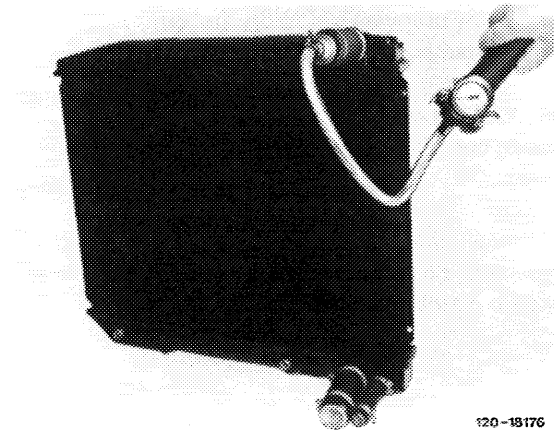

6 Place radiator into a water bath.

7 Put the radiator under pressure by means of the tester and watch for air bubbles.

8 Mark leaking area.

9 Remove radiator and release pressure.

10 Blow radiator dry with compressed air.

11 Clean part to be sealed by means of a commercially available cleaning compound (e.g. Tri or benzine). Always clean a slightly larger area than the spot to be sealed (e.g. for cracks, approx. 20—30 mm beyond the end of the cracks).

There is no need to remove paint. The radiator can then be blown dry at the respective area by means of compressed air.

No dust or grease should remain.

12 Evenly and thinly distribute priming fluid with a brush.

Similar to cleaning, apply priming fluid beyond the area to be sealed. To prevent the priming fluid from becoming dirty in the container, pour the quantity required for the repair into a separate vessel.

Caution!

When handling priming fluid, pay attention to safety regulations. Dangerous materials class A 1, inflammable.

13 Allow priming fluid to dry for approx. 10 minutes at room temperature.

14 Position radiator in such a manner that the sealing compound cannot run off the spot to be sealed.

15 Apply diluted or non-diluted sealing compound depending on accessibility. Use brush, spatula or the like for distributing the sealing compound.

Caution!

During application and distribution make sure that no air pockets will occur.

Apply sealing compound similar to cleaning and priming beyond the spot to be sealed. If there are several leaking points on the beaded collar (arrows), it is recommended to seal the beaded collar all the way round.

Seal leaks in the core from both sides.

At the end of the sealing procedure, close the tube again immediately. Acetic acid will be liberated until linking (setting) of sealing compound has been completed. Avoid skin contact. Clean affected areas immediately with water and soap, rinse eyes with water and see a doctor if required.

16 For drying of sealing compound, leave radiator lying or standing up for at least 3 hours. Depending on the quantity of sealing compound applied and the size of the area to be sealed, linking of sealing compound into a permanent, elastic bond will be completed after a maximum of 24 hours at room temperature.

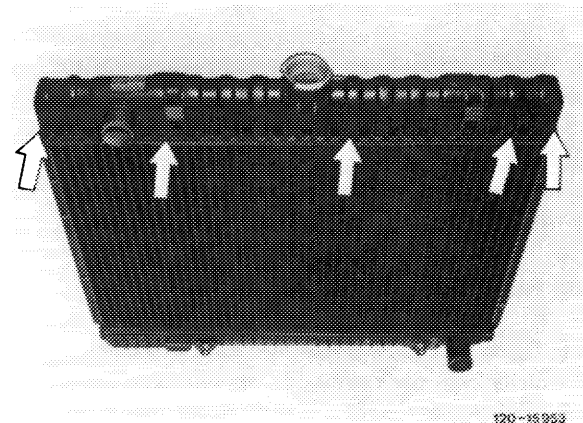

17 Pressure-test the radiator in a water bath for approx. 5 minutes at 1.5 bar gauge pressure.

If there are still other leaks, repeat the sealing process starting with item 8.

18 Remove tester and plugs.

19 Attach air oil cooler to radiator and tighten fastening screws to 6 Nm.

20 Following the installation of radiator (20–420) and filling-in of coolant (20–010), pressure-test cooling system with tester (1.0 to 1.3 bar gauge pressure) to check for leaks.