





V-belt dimensions

Engine	Version	A Coolant pump power steering pump	B Alternator	C Refrigerant compressor	D Air pump ⁴⁾
116.960 116.961	Standard	9.5 x 1140 ¹⁾ ; 9.5 x 1150 ²⁾ (2 each) ⁵⁾	9.5 x 920	12.5 x 868 ¹⁾) 12.5 x 880 ²⁾	—
	 1981	9.5 x 1130 (2 each) ⁵⁾	9.5 x 950	12.5 x 920	
	 1981	9.5 x 1100 (2 each) ⁵⁾	9.5 x 990 9.5 x 900 ⁶⁾	12.5 x 930	9.5 x 750
 1982					
Standard  1982	12.5 x 920				
116.962 116.963				12.5 x 960 ⁷⁾	
116.964 116.965					
117.960	Standard	9.5 x 1150 ¹⁾) 9.5 x 1130 ²⁾) 9.5 x 1110 ³⁾) (2 each) ⁵⁾	9.5 x 1000 ¹⁾) 9.5 x 960 ²⁾	12.5 x 868 ¹⁾) 12.5 x 910 ²⁾) 12.5 x 920 ³⁾	—
117.961		9.5 x 1100 (2 each) ⁵⁾	9.5 x 1005 ¹⁾) 9.5 x 960 ²⁾	12.5 x 910 ¹⁾) 12.5 x 920 ²⁾	—
117.962 117.963			9.5 x 1005 9.5 x 900 ⁶⁾	12.5 x 920	—
117.964 117.965 117.967 117.968				12.5 x 960 ⁷⁾	—

1) 1st version

2) 2nd version

3) 3rd version

4) Only 

5) Install double V-belts only in pairs and made by one and the same manufacturer only.

6) Special protection vehicles with 2nd alternator.

7) With Nippondenso compressor and light alloy bracket as of August 1985.

V-belt	Arrangement	Adjusting value (KG scale on measuring device)	
		New V-belts	Used V-belts
A	Coolant pump – power steering pump ¹⁾	30	20–25
B	Alternator	35	30–35
C	Refrigerant compressor	50	40–45
D	Air pump	30	20–25

¹⁾ Double V-belt.

Special tools

Measuring instrument (Krikitt)
for measuring V-belt tension



001 589 69 21 00

Screwdriver 10 mm for
internal socket head bolt tension roller
V-belt – refrigerant compressor



117 589 03 07 00

Note

The measuring instrument „Krikitt“ is recommended
for testing V-belt tension.

- | | |
|--------------------------|-----------------------|
| 1 Crankshaft | 5 Tension roller |
| 2 Coolant pump | 6 Power steering pump |
| 3 Alternator | 7 Air pump |
| 4 Refrigerant compressor | |

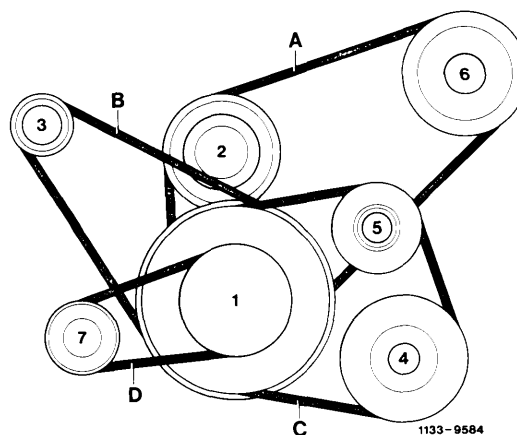

Use of measuring instrument

To check V-belt tension, the measuring instrument
can be held in several ways:

- a) With thumb and index finger at rubber loop, with
finger tips resting on push-button.

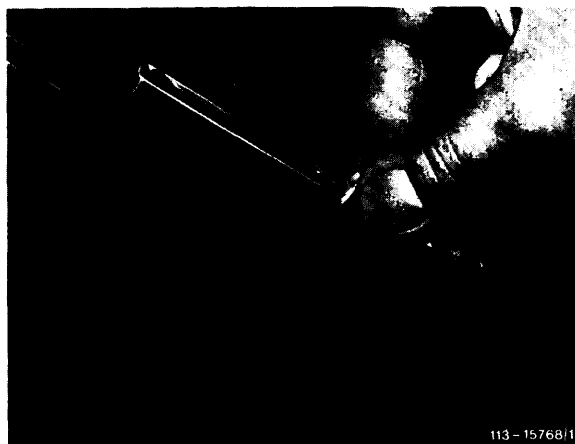

b) With index finger from above in rubber loop.

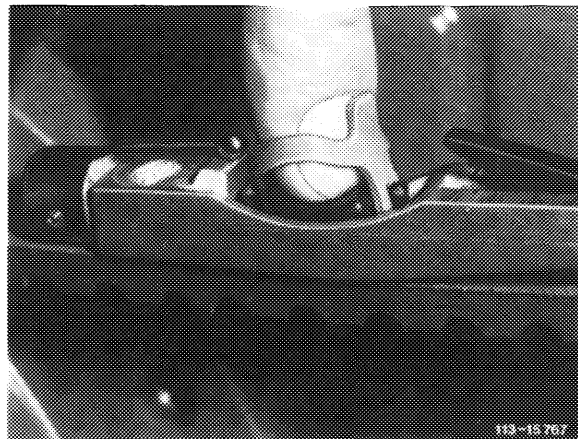

c) With index finger laterally between rubber loop and push-button.

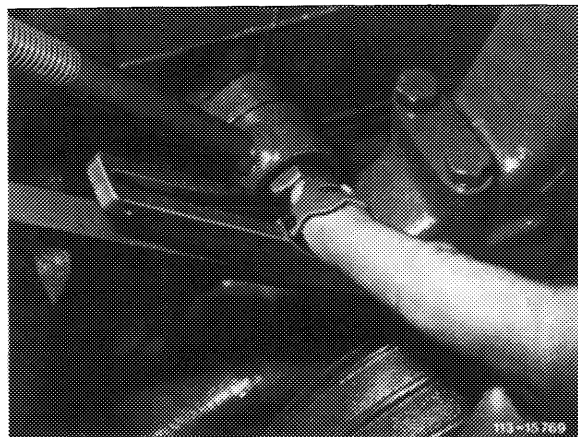

Checkup

1 Lower indicating arm on measuring instrument.

2 Place measuring instrument on V-belt in the center between the pulleys. The stop of the measuring instrument should rest laterally against the V-belt (arrow).

Caution!

On double belt drive, make sure that the measuring instrument rests on one V-belt only.

3 Exert even vertical pressure on the top of the V-belt with the push-button until the clicking spring disengages audibly or noticeably.

Note: Following disengagement of click spring, do not continue pushing with measuring instrument as this will indicate a wrong value.

4 **Carefully** lift measuring instrument off V-belt. Avoid knocks and do not change position of indicator arm.

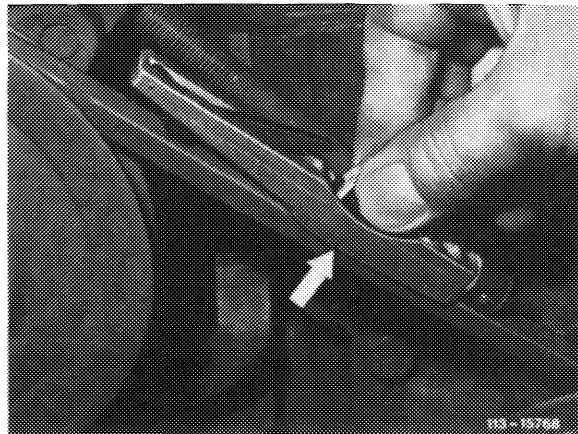

5 Read adjusting value on intersection of indicating arm and upper scale (KG scale, arrow).

The specified adjusting values refer to the KG scale of the measuring instrument.

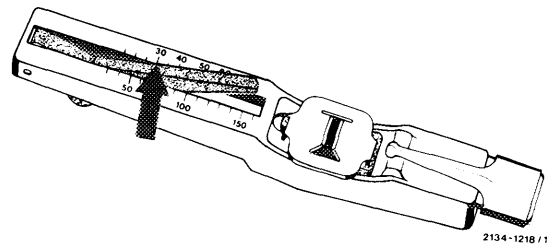

Replacement

Check condition of V-belt.

Replace cracked, burnt or worn V-belts.

Caution!

If on a double belt drive for coolant pump and power steering pump one of the two V-belts fails due to wear, make sure that both V-belts are replaced together.

Install only V-belts made by one and the same manufacturer.

V-belts as spare parts are available in pairs only.

- 1 Loosen tension devices or units.
- 2 Mount V-belt without using force.
- 3 Tension V-belt.

Tensioning

V-belt A Coolant pump – power steering pump

- 1 Loosen nuts (1, 2 and 3 [pivot point]), on power steering pump bracket.

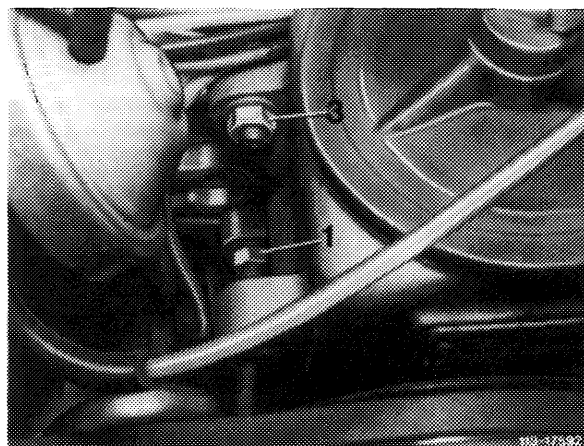

2 Tension V-belt with tension screw (arrow).

3 Tighten nuts (1, 2 and 3).

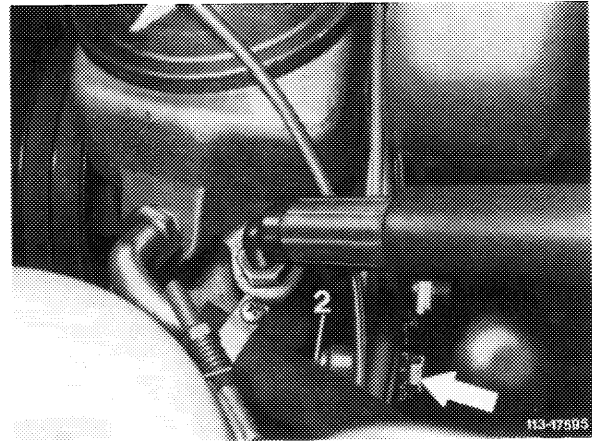

V-belt B Alternator

1 Slightly loosen fastening bolt (1) and nuts (2 and 3) on alternator bracket.

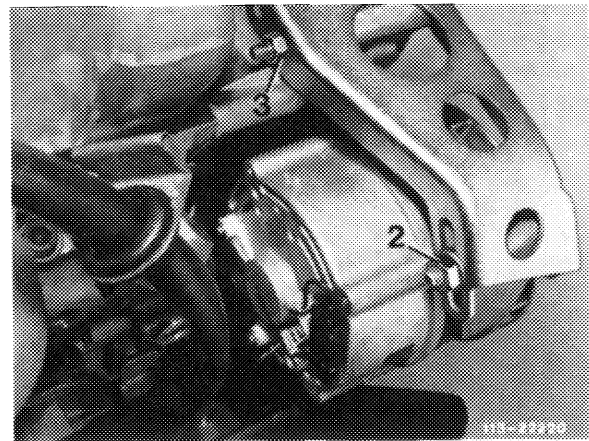

2 Tension V-belt with tension screw (4).

3 Tighten fastening bolt (1) and nuts (2 and 3).

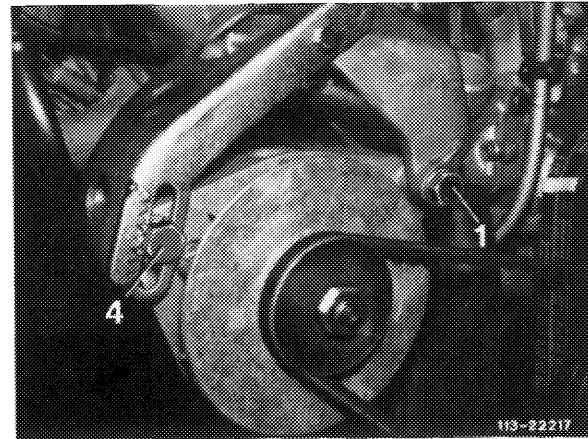

V-belt C Refrigerant compressor

1 Loosen fastening bolt (9) of tension roller (8).

2 Tension V-belt by swivelling tension roller (8). For this purpose, fit an open end wrench (19 mm) on the flat (10).

3 Tighten mounting bolt (9).

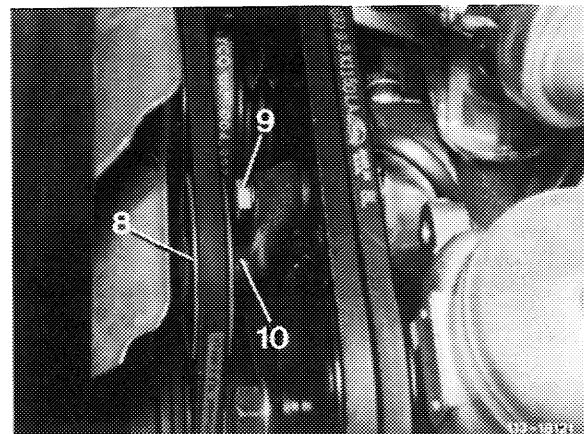

Note

Access to the attaching bolt (9) was improved by means of a changed bracket (version B).

This bracket is attached with a bolt M 12 x 1.5 x 35 (was M 12 x 1.5 x 40).

In the event of repairs, the tension roller and the bracket can be installed on the previous engines as well.

As of November 1985, the bracket for the tension roller is attached with an internal socket-head bolt. The internal socket-head bolt must be loosened with the 10 mm screwdriver 117 589 03 00.

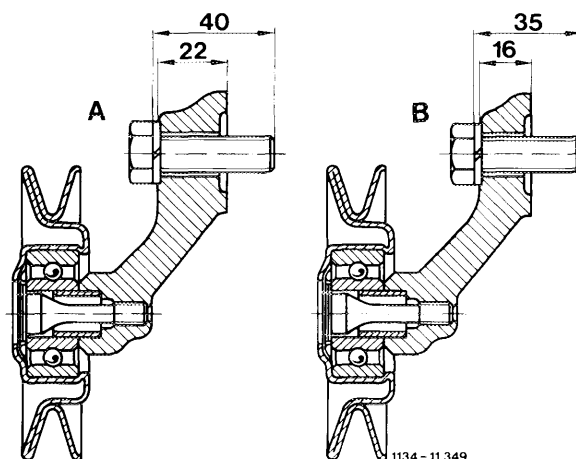

A 1st version
B 2nd version

V-belt D Air pump

KAT as of 1985
AUS J S USA as of 1981
CH as of 1983

1 Loosen mounting bolts (1 and 2).

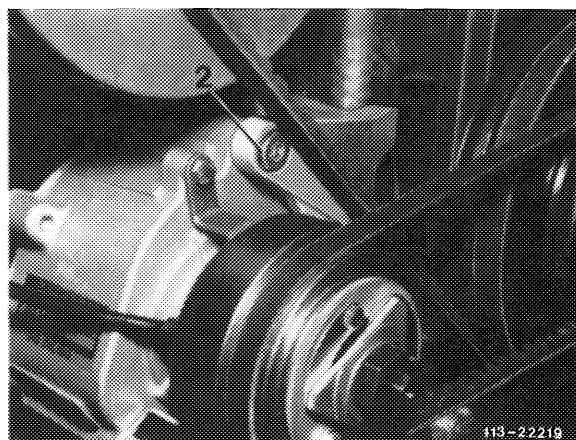

2 Tension V-belt with tension nut (3).

3 Tighten mounting bolts (1 and 2).

