

01—112 Measuring, honing and silicon—lapping cylinder bores

Allocation	Group No.	Cylinder diameter	Piston diameter
Engines 116.960/961/964/965			
Standard size Std 92.0 dia.	0	91.998—92.003	91.985—91.990
	0+	92.003—92.008	91.990—91.995
	1	92.008—92.013	91.995—92.000
	1+	92.013—92.018	92.000—92.005
	2	92.018—92.023	92.005—92.010
	2+	92.023—92.028	92.010—92.015
1st repair stage +0.5 ¹)	0	92.498—92.503	92.485—92.490
	1	92.508—92.513	92.495—92.500
	2	92.518—92.523	92.505—92.510
2nd repair stage +1.0 ¹)	0	92.998—93.003	92.985—92.990
	1	93.008—93.013	92.995—93.000
	2	93.018—93.023	93.005—93.010
Engines 116.960 (AUS) (J) (USA) , 116.961 (AUS) (J) (S) (USA) 116.962/963			
Standard size Std 88.0 dia.	0	87.998—88.003	87.985—87.990
	0+	88.003—88.008	87.990—87.995
	1	88.008—88.013	87.995—88.000
	1+	88.013—88.018	88.000—88.005
	2	88.018—88.023	88.005—88.010
	2+	88.023—88.028	88.010—88.015
1st repair stage +0.5 ¹)	0	88.498—88.503	88.485—88.490
	1	88.508—88.513	88.495—88.500
	2	88.518—88.523	88.505—88.510
2nd repair stage +1.0 ¹)	0	88.998—89.003	88.985—88.990
	1	89.008—89.013	88.995—89.000
	2	89.018—89.023	89.005—89.010

¹) Pistons of the repair stages are only available with the group numbers 0, 1 and 2.

Engine 117.960 up to end No. 000885

	0	96.998–97.003	96.985–96.990
	0+	97.003–97.008	96.990–96.995
Standard size Std 97.0 dia.	1	97.008–97.013	96.995–97.000
	1+	97.013–97.018	97.000–97.005
	2	97.018–97.023	97.005–97.010
	2+	97.023–97.028	97.010–97.015
1st repair stage +0.5 ¹⁾	0	97.498–97.503	97.485–97.490
	1	97.508–97.513	97.495–97.500
	2	97.018–97.523	97.505–97.510

**Engines 117.960 as of end No. 000886
117.961/962/963/964/965/967/968**

	0	96.498–96.503	96.485–96.490
	0+	96.503–96.508	96.490–96.495
Standard size Std 96.5 dia.	1	96.508–96.513	96.495–96.500
	1+	96.513–96.518	96.500–96.505
	2	96.518–96.523	96.505–96.510
	2+	96.523–96.528	96.510–96.515
1st repair stage +0.5 ¹⁾	0	96.998–97.003	96.985–96.990
	1	97.008–97.013	96.995–97.000
	2	97.018–97.023	97.005–97.010
2nd repair stage +1.0 ¹⁾	0	97.498–97.503	97.485–97.490
	1	97.508–97.513	97.495–97.500
	2	97.518–97.523	97.505–97.510

¹⁾ Pistons of the repair stages are only available with the group numbers 0, 1 and 2.

Piston clearance	when new	0.008–0.018
	wear limit	0.08
Maximum wear limit of cylinder bores in driving or transverse direction at upper and lower points of return of 1st piston ring		0.10

Machining tolerances

Permissible deviation from cylindrical shape	when new	0.013
	wear limit	0.05
Permissible deviation from rectangularity with reference to cylinder height		0.05
Mean roughness (Rz) after polishing		0.001
Mean roughness (Rz) after silicon-lapping		0.001–0.003
Permissible peak-to-valley-height (Wt)	50% of the roughness after silicon-lapping	
Cylinder bore chamfer		see Fig. No. 14

Conventional tools

Automatic cylinder reconditioning machine
SUNNEN CK-10-G with honing oil filter and oil cooler

Honing head CK-3000 for 76–127 mm dia.

SUNNEN honing oil MB 30¹)

Prehoning, stone set C 30-A 53, 70 mm long²)

Finish honing, stone set C 30-J 84, 70 mm long²)

Polishing, stone set C 30-C 03-81

Stone holder for felt insert CK-30 35

Felt insert holder set CK-3130

Felt insert C 30-F 85

SUNNEN silicon paste AN-30

Box for silicon paste and
felt inserts AN-35

Inside measuring instrument (dial gauge) for 50 to 150 mm
diameter, with 0.01 mm division and spring-loaded
measuring tip, e.g. Sunnen GRM 2125

Setting micrometer for inside measuring instrument GAM
2125 with setting range 50–200 mm, e.g. Sunnen CF-1000 M

Federal Republic of Germany:
e.g. Hommel Handel GmbH
Donatusstraße 24, D–5000 Köln 71

Other countries:
e.g. SUNNEN Products Comp.
USA–7910 Manchester
St. Louis, Mo. 63143

Hommel Handel Export Division
P.O. Box 1206
D–6806 Viernheim

¹) Initial filling approx. 170 liters.

²) These stones are only available with a length of 89 mm and must be shortened at the top to 70 mm using a metal saw (see Fig. 3).

Note

The light metal cylinder bores are very sensitive to damage, scratches and dirt and therefore should be treated very carefully.

When honing, the cylinder bores should be matched to the dimensions of the existing repair stage pistons with group numbers 0, 1 or 2, while maintaining the specified piston clearance.

Measuring

When measuring the cylinder bores, use a measuring instrument with spring-loaded measuring tip to prevent score marks on cylinder running surface through the measuring point contact and premature wear of the instrument measuring pins.

Set the self-centering inside measuring instrument to the cylinder diameter before measuring, and measure at 22–24 °C room temperature.

Inside measuring instrument with setting micrometer

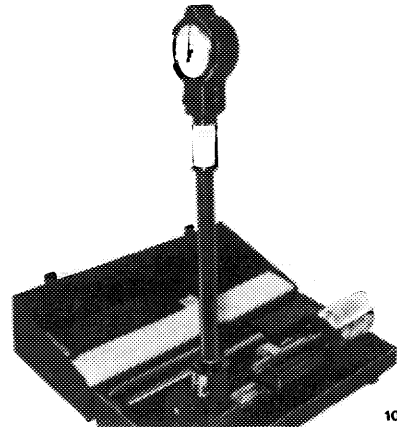

101 – 18671

The aluminum surface recession (0.5–1.5 μm) between the silicon crystals can only be measured indirectly via the mean roughness (Rz) after silicon-lapping (end condition).

The specified exposed depth of the silicon crystals is obtained by the temporally limited control during silicon-lapping and the choice of silicon paste used.

Honing and silicon-lapping

With severely scored and worn cylinder ($> 0.10 \text{ mm}$) etc., the cylinder bores can be honed to the specified repair stages.

After honing, the silicon crystals must remain intact and flattened on the cylinder surface.

The honing processes (prehoning, finish honing and polishing) must be followed by „silicon-lapping“ according to the Sunnen process in order to expose the silicon crystals.

Omission of the job „silicon-lapping“ invariably leads to piston seizures.

Caution!

The following jobs must only be carried out with a honing machine with honing oil filter and oil cooler.

The silicon particles must be separated from the honing oil by filtering.

The honing oil must be cooled to a constant temperature of 20 °C to avoid excessive heating of the cylinder crankcase.

In order to obtain a good honing quality it is necessary to use only the specified honing oil.

1 Set up honing machine CK-10-G.

Carry out all honing and lapping work without directional guide shoes.

The protrusion of the honing stone (arrow) is 14 mm.

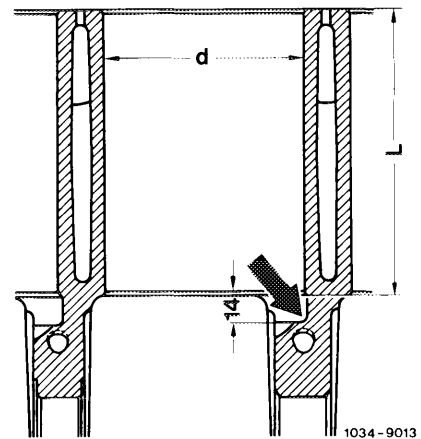

2 Cut the lower protrusion of the bronze strip on the main guide shoe (arrow) as the recess at the bottom of the cylinders allows only approx. 14 mm protrusion of the honing stone.

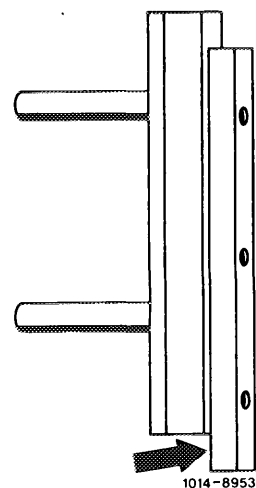

3 The specified stone sets of 89 mm length must be shortened to 70 mm. To do so, cut the honing stone at the top (not the holder) using a metal saw.

Dimension a = 70 mm

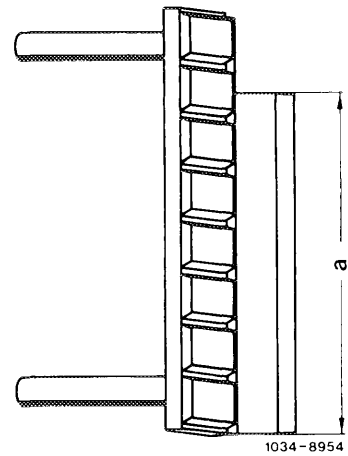

4 Torque the crankshaft bearing cap bolts and nuts in the sequence of the tightening diagram with 50 Nm.

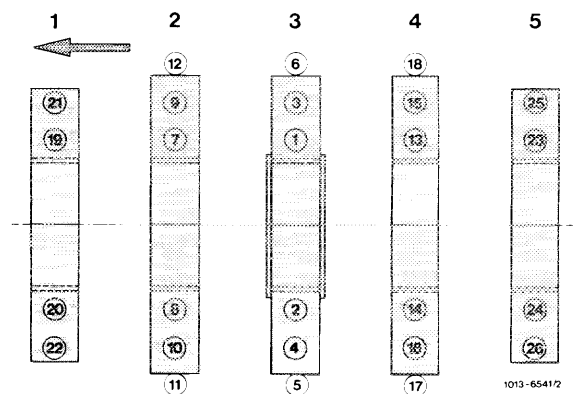

5 Fix disassembled and cleaned cylinder crankcase with fitted and tightened crankshaft bearing caps in the honing machine by means of the square steel.

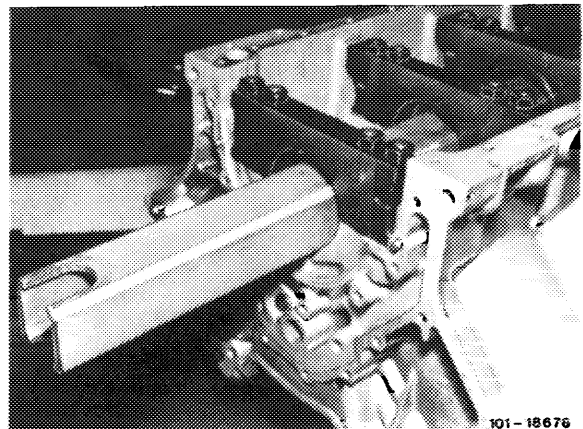

6 Adjust stroke (cylinder length) on the stroke scale according to the table „Prehoning“.

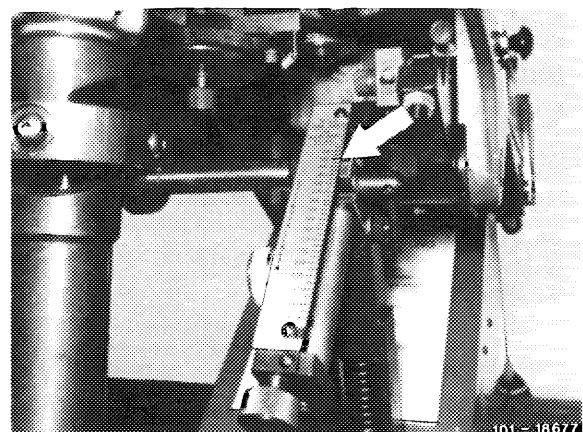

7 Adjust stone projection (arrow) with the gauge according to the table.

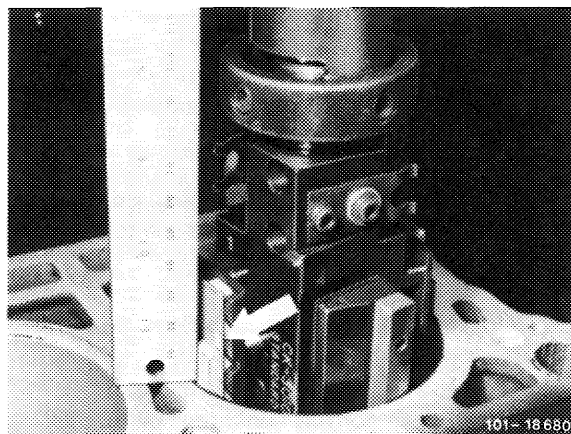

8 Adjust feed (arrow) according to the table.

9 Adjust strokes per minute and revolutions per minute according to the table.

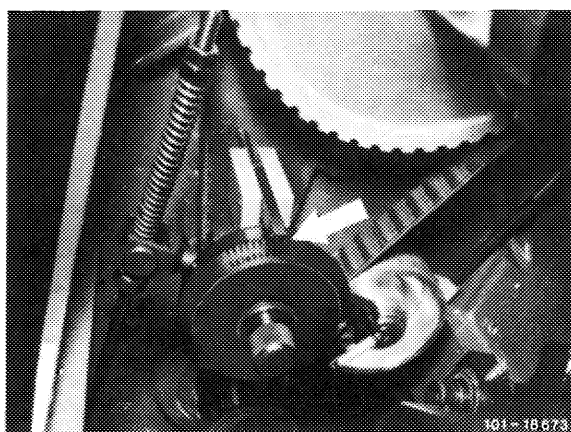

Prehoning

Setting up of honing machine

Engine	116.960	116.960 ²⁾) ⁴⁾	117.960 ¹⁾	117.964	117.960 ¹⁾
	116.961	116.961 ²⁾	117.961	117.965	
	116.964	116.962 ³⁾) ⁴⁾	117.962	117.967	
	116.965	116.963 ³⁾	117.963	117.968	
Cylinder dia. setting for 1st repair stage (+0.5)		92 mm	88 mm	96.5 mm	97 mm
Cylinder length		135 mm	135 mm	155 mm	
Stroke setting		137 mm	137 mm	157 mm	
Speed/min			125		
Strokes/min			49		
Feed			4		
Stone protrusion			approx. 12 mm		
Prehoning stone set			C 30-A 53		
Indication %			approx. 30		
Material removal/min			0.07 mm		
Feed scale/material removal			10 divisions/0.05 mm		

1) Up to engine end No. 000885 cylinder dia. 97 mm.

2) (AUS) (J) (S) (USA) model year 1981.

3) Standard version and (AUS) (J) (S) (USA) as of model year 1982.

4) Only (AUS) (J) (USA)

10 Prehone all cylinder bores with full honing oil supply up to approx. 0.08 mm before the final dimension, since otherwise the silicon crystals will be torn out or damaged by the cutting pressure.

Caution!

When measuring directly after pre honing, a dimension of approx. +0.02 mm is obtained due to a rise in temperature.

The heating-up of the cylinder crankcase is also dependent on the ambient temperature.

11 Insert stone set for fine honing and cut to size as described under figure 3.

12 Set up honing machine according to the table „Fine honing“.





Fine honing



Setting up of honing machine

Engine	116.960 116.961 116.964 116.965	116.960 ²) ⁴) 116.961 ²) 116.962 ³) ⁴) 116.963 ³)	117.960 ¹) 117.961 117.962 117.963	117.964 117.965 117.967 117.968	117.960 ¹)
Cylinder dia. setting for 1st repair stage (+0.5)		92.42 mm	88.42 mm	96.92 mm	97.42 mm
Cylinder length		135 mm	135 mm	155 mm	
Stroke setting		137 mm	137 mm	157 mm	
Speed/min			125		
Strokes/min			49		
Feed			3		
Stone projection			approx. 12 mm		
Finish honing stone set			C 30-J 84		
Indication %			approx. 30		
Material removal/min			0.05 mm		
Feed scale/material removal			10 divisions/0.05 mm		

¹) Up to engine end No. 000885 cylinder dia. 97.42 mm.

²)     model year 1981.

³) Standard version and     as of model year 1982.

⁴) Only   

13 Fine-hone all cylinder bores with full honing oil supply up to approx. 0.02 mm before reaching the final dimension.

Caution!

Measuring directly after fine-honing, a dimension of approx. +0.01 mm is obtained as a result of temperature increase. The heating-up of the cylinder crank-case is also dependent on the ambient temperature.

14 Chamfer cylinder bores according to drawing prior to „polishing“.

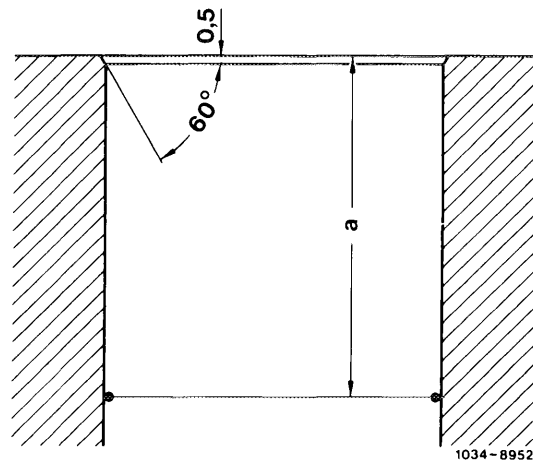

15 For chamfering, use a suitable hand milling tool with an angle according to the above drawing.

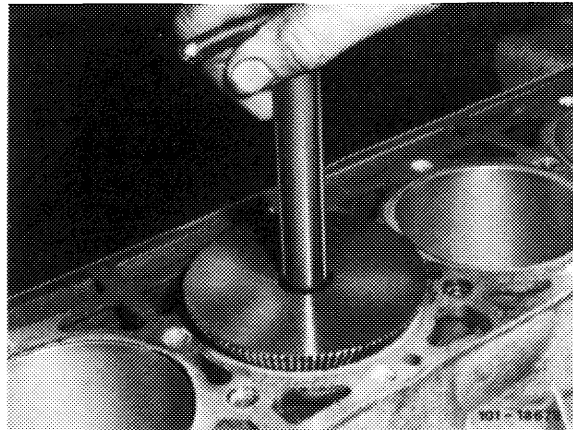

16 Insert stone set for polishing.

Prior to machining, the new polishing stones should be straightened in the narrowest cylinder bore.

17 Set up honing machine according to the table „Polishing“.

Polishing

Setting up of honing machine

Engine	116.960	116.960 ^{2) 4)}	117.960 ¹⁾	117.960 ¹⁾
	116.961	116.961 ²⁾	117.961	
	116.964	116.962 ^{3) 4)}	117.962	
	116.965	116.963 ³⁾	117.963	
			117.964	
			117.965	
			117.967	
			117.968	
Cylinder dia. setting for 1st repair stage (+0.5)	92.48 mm	88.48 mm	96.98 mm	97.48 mm
Cylinder length	135 mm	135 mm	155 mm	
Stroke setting	137 mm	137 mm	157 mm	
Speed/min		125		
Strokes/min		49		
Feed		2		
Stone projection		approx. 12 mm		
Polishing stone set		C 30-C 03-81		
Indication %		approx. 30		
Material removal/min		0.01 mm		
Feed scale/material removal		10 divisions/0.01 mm		

1) Up to engine end No. 000885 cylinder dia. 97.48 mm.

2) (AUS) (J) (S) (USA) model year 1981.

3) Standard version and (AUS) (J) (S) (USA) as of model year 1982.

4) Only (AUS) (J) (USA)

18 Polish all cylinder bores with full honing oil supply until the end dimension has been reached.

19 Allow cylinder crankcase to cool down.

20 Measure cylinder bores, while taking into account the required cylinder diameter (group No.) for the existing pistons and the specified piston clearance.

Repolish if required.

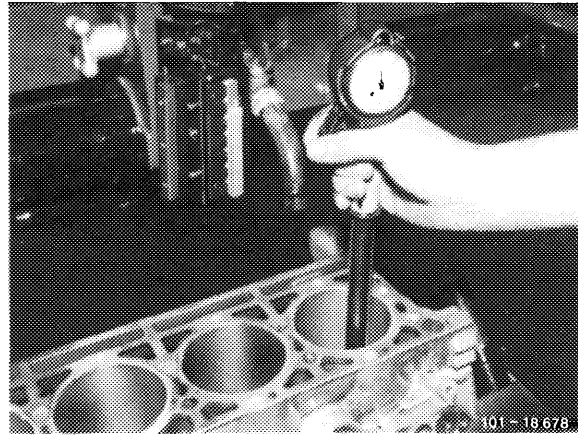

21 Clean cylinder walls with filtered honing oil to remove all silicon particles and to avoid scratches during the subsequent silicon-lapping process.

22 Press felt inserts (C 30-F 85) into the holders CK-3130 and these into the stone holders CK-3035.

Caution!

After the felt inserts have been pressed into the holder, remove all material which has been scraped off in the process.

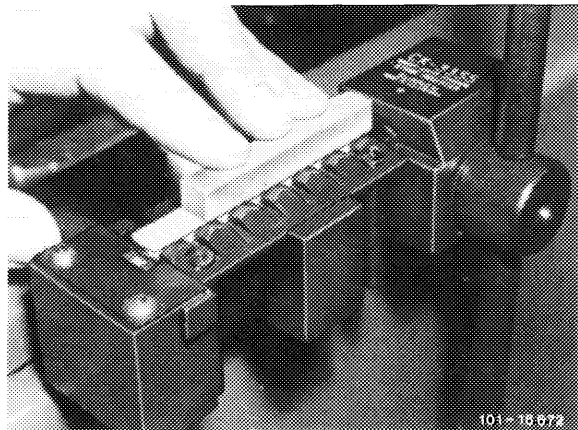

23 Set up the cylinder diameter by means of the setting gauge.

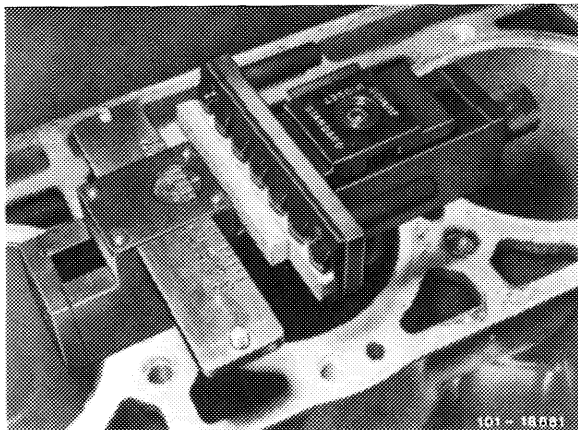

24 Soak felt inserts with filtered honing oil and insert into the honing head.

25 Cut honing oil supply.

26 Set up honing machine according to the table „Silicon-lapping“.

Silicon-lapping

Setting up of honing machine

Engine	116.960 116.961 116.964 116.965	116.960 ²⁾) ⁴⁾ 116.961 ²⁾ 116.962 ³⁾) ⁴⁾ 116.963 ³⁾)	117.960 ¹⁾ 117.961 117.962 117.963 117.964 117.965 117.967 117.968	117.960 ¹⁾
Cylinder dia. setting for 1st repair stage (+0.5)	92.50 mm	88.50 mm	97.00 mm	97.50 mm
Cylinder length	135 mm	135 mm	155 mm	
Stroke setting	120 mm	120 mm	140 mm	
Speed/min		185		
Strokes/min		73		
Feed		2		
Felt insert projection		approx. 2 mm		
Felt insert		C 30-F 85		
Indication %		approx. 30		
Material removal/min		not measurable		
Feed scale		18 divisions \approx 70 s running time		

¹⁾ Up to engine end No. 000885 cylinder dia. 97.5 mm.

²⁾ (AUS) (J) (S) (USA) model year 1981.

³⁾ Standard version and (AUS) (J) (S) (USA) as of model year 1982.

⁴⁾ Only (AUS) (J) (USA)

27 Thoroughly stir silicon paste AN-30 and fully coat the dry cylinder walls.

28 Likewise coat the felt inserts with silicon paste.

29 Introduce honing head with felt inserts into cylinder bore.

30 With honing machine running, slowly turn feed wheel to the right until the indicator reaches 30 %.

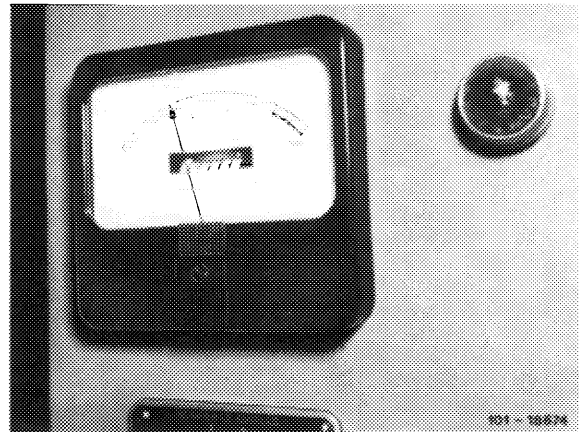

31 Set feed scale to 18 divisions.

The honing machine will switch off after approx. 80 seconds. The cylinder surface will then have a dull appearance.

No honing marks will be visible.

The roughness is 0.001–0.003 mm.

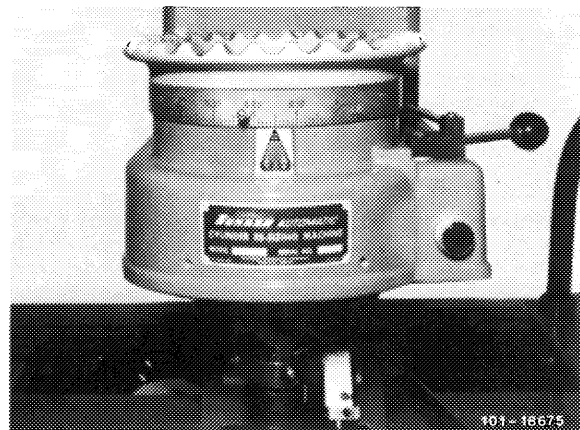

32 Thoroughly clean cylinder bores of all silicon traces using filtered honing oil and a suitable brush, then dry.

Used silicon paste may not be reused!

