

01-030 Removal and installation of engine (oil capacity)

Specified viscosity classes according to SAE during lasting ambient temperatures

- 1) SAE 40 may be used during lasting outside temperatures above +30 °C (+86 °F).
- 2) For engine oils identified on sheets 226.1 and 227.1 of Specifications for Service Products with footnote 1), the following applies:
SAE 5 W-20 below +10 °C.
SAE 10 W-30 in temperate zones all seasons; i.e. up to +30 °C.
SAE 15 W-30 in temperate zones all seasons.
- 3) All-season oil.

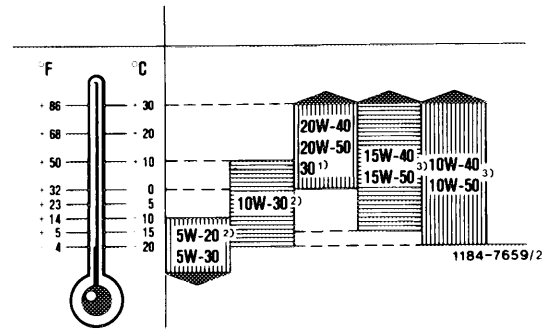

Oil capacity in liters (for approved engine oils refer to Specifications for Service Products)

Engine (total filling capacity)	New filling (dry engine)	8.5 ¹⁾
	With oil and filter change	8.0

¹⁾ On vehicles with air-oil cooler 0.5 liter additionally.

Tightening torques		Nm
Oil drain plug of oil pan	M 26	50
	M 12	40
Central screw — oil filter cover	Model 126	25
Attaching screw for oil filter lower part	Model 107	35

Special tools

Tester for cooling system and radiator or expansion tank cap

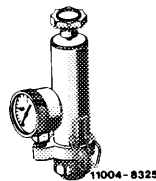

001 589 48 21 00

Radiator cap with hose for leak test

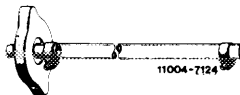

605 589 00 25 00

Adapter for checking radiator cap in connection with tester

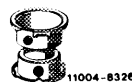

000 589 73 63 00

Conventional tool

Engine hoist size 1.5

e.g. Wilibär, D-5630 Remscheid

Note

On model 126, raise engine hood into 90° position and engage left detent lever (arrow).

On model 107, remove engine hood.

Remove and install engine with transmission at an inclination of approx. 45°.

Removal

1 Drain coolant.

Caution!

The drain plugs (2) are arranged at the left and right of the cylinder crankcase.

The lateral crankshaft bearing cap bolts (arrows) should not be confused with the coolant drain plugs.

2 Drain plug left

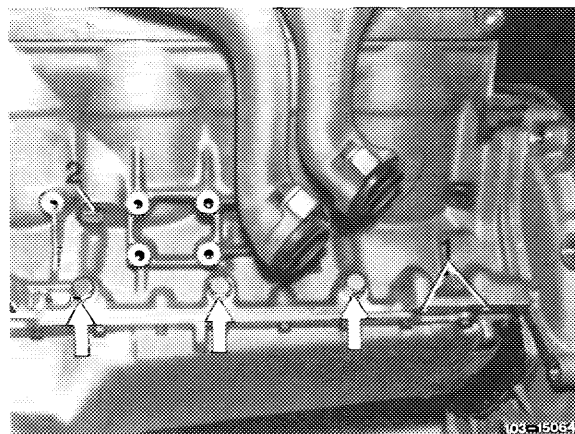

2 Drain plug right

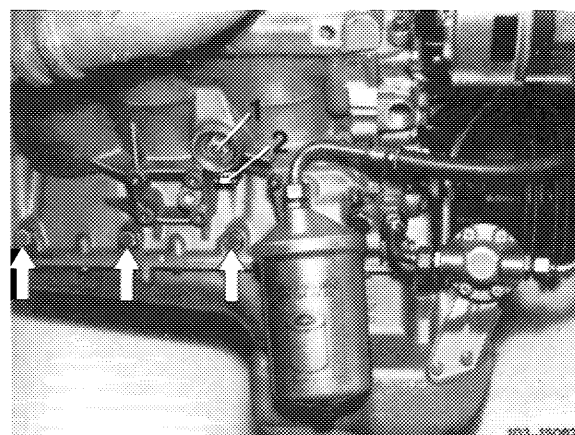

2 On vehicles with air conditioning or automatic climate control, these should be drained and hoses disconnected at the pipe pair (arrow) (83-516).

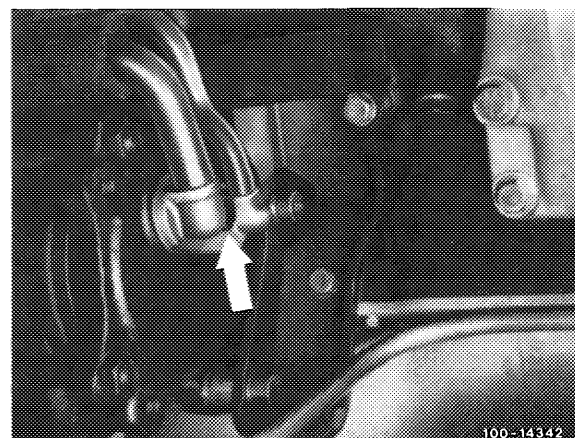

- 3 Remove radiator and fan.
- 4 Remove complete exhaust system.

5 Press control arm (4) off right ball head (only model 107).

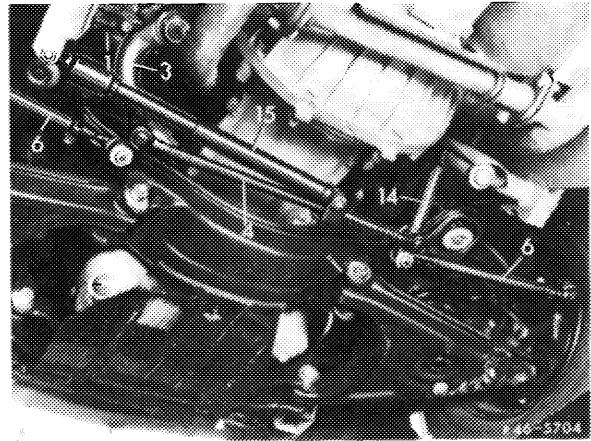

- 6 Evacuate power steering pump reservoir.
- 7 Disconnect pressure hose on power steering.
- 8 Disconnect all coolant, vacuum, oil, fuel and electrical lines and other connections leading to the engine.
- 9 Unscrew cable for TDC transmitter from diagnostic socket. Remove screw (4) and pull out transmitter (3).
- 10 Disconnect control shaft.

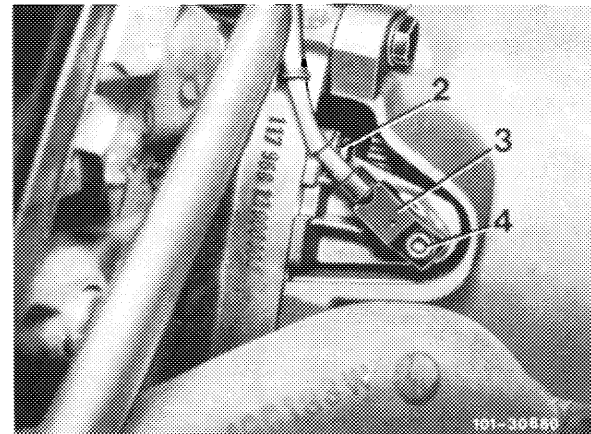

11 Unscrew attaching screws (arrow) at left and right of engine mount.

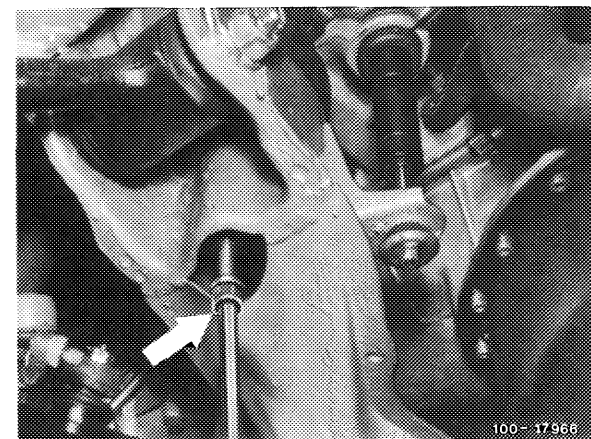

12 Remove engine shock absorbers left and right.

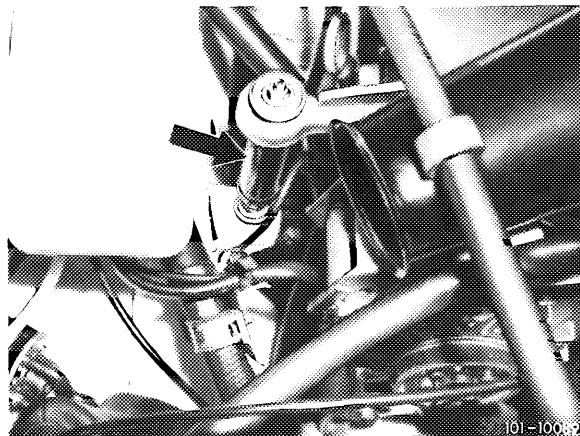

Model 107

13 Attach engine hoist cables to the lifting eyes.

14 Remove rear engine cross member or bulkhead with engine mount.

15 Disconnect drive shaft from transmission.

16 Loosen connections on transmission.

17 Lift out engine at an inclination of 45°.

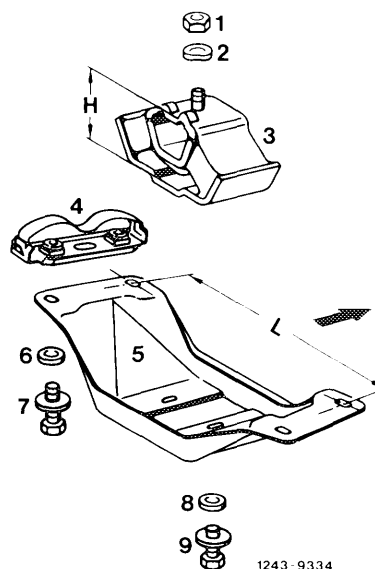

Installation

Caution!

When installing a new engine after a previous bearing failure, carefully flush oil hoses, renew oil cooler. Disassemble and clean oil damper.

18 Check engine mounts, coolant, vacuum, oil and fuel hoses, renew if required.

Caution!

When installing the refrigerant compressor carrier (steel version) it is important to ensure stress-free assembly.

The carrier (steel version) must be checked for distortion. It must rest evenly on all contact points of the cylinder crankcase without gap. This condition should be checked before tightening the bolts.

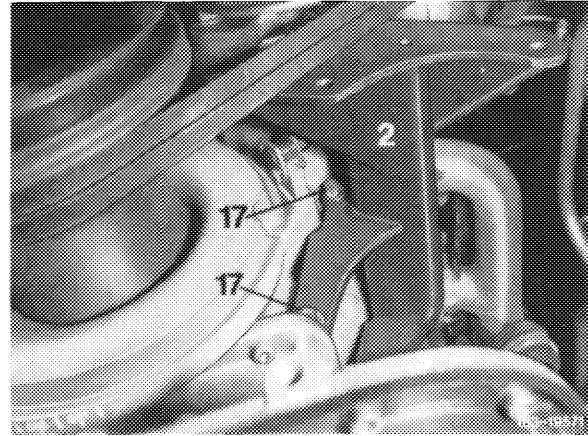

The bolts must be tightened in the following sequence:

- a) Install bolts (17, 6 and 5) finger-tight.
- b) Tighten bolts (17) at engine front.
- c) Tighten bolt (6) and nut (5) at side of engine.

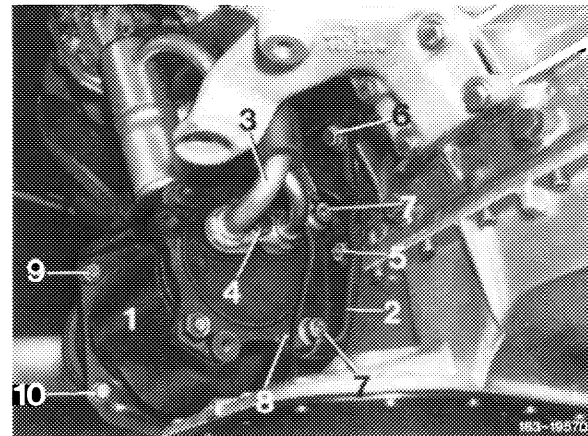

- 19 Install and connect engine.
- 20 Install rear engine mount without tension. Tighten set screw with 30 Nm.
- 21 Ensure that all drain plugs are tight.
- 22 Fill in oils (exchange engines and overhauled engines initial operation oil according to sheet 225.3 „Specifications for Service Products“), coolant and refrigerant.
- 23 Check cooling system with leak tester for leaks.
Check antifreeze capacity of coolant.
- 24 Connect control linkage and check function.
- 25 Clean air filter and renew if necessary.
- 26 Clean air cleaner and renew if necessary.
- 27 Set idle speed