

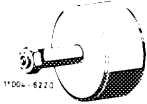



Tightening torques	Nm	(kpm)
Bolts for cylinder head cover (engine 615)	5	(0.5)
Nuts for cylinder head cover (engines 615, 616, 617)	15	(1.5)
Waisted bolt for camshaft sprocket	80	(8)
Delivery oil pump to cylinder head	10	(1)

Special tools

Impact extractor for bearing pin (basic unit)		116 589 20 33 00
Threaded stud M 8, 150 mm long for impact extractor		616 589 00 34 00
Threaded stud M 6, 50 mm long for impact extractor		116 589 01 34 00
Socket 27 mm, 1/2" drive to crank engine		001 589 65 09 00

Note

If, on engines with level control, it is necessary to replace the rear bearing bushing for the idler gear shaft, make sure that the bearing bushing projects from basic bore by 1 mm. It must not be inserted flush.

Removal

1 On vehicles with level control, unscrew delivery oil pump together with connected lines, depositing on one side.

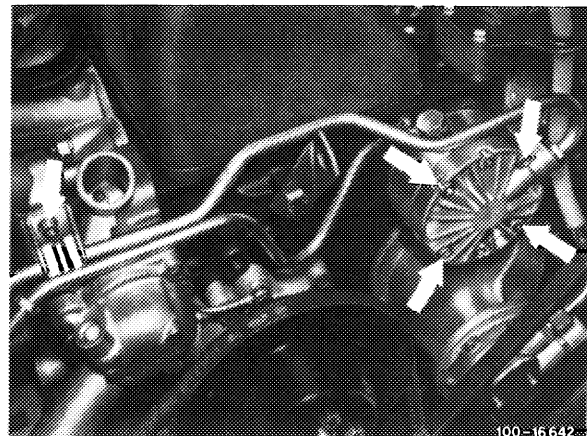

100-16642

2 Remove cylinder head cover.

On vehicles with automatic transmissions and vacuum-controlled modulating pressure, additionally detach vacuum lines at switch-over valve.

Caution:

Be sure not to cross vacuum lines. The pipe unions and vacuum lines are color coded.

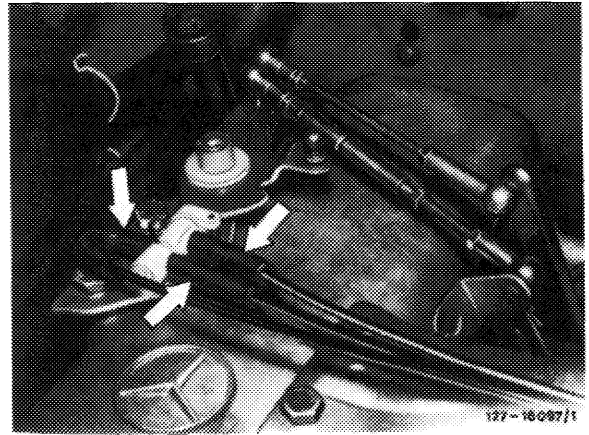

On engines with longitudinal control spindles, detach all control rods. Withdraw retainer (arrow) and force longitudinal control spindle in aft direction. Unscrew bracket (1) and unclip idle control cable (2) with plastic sleeve (3).

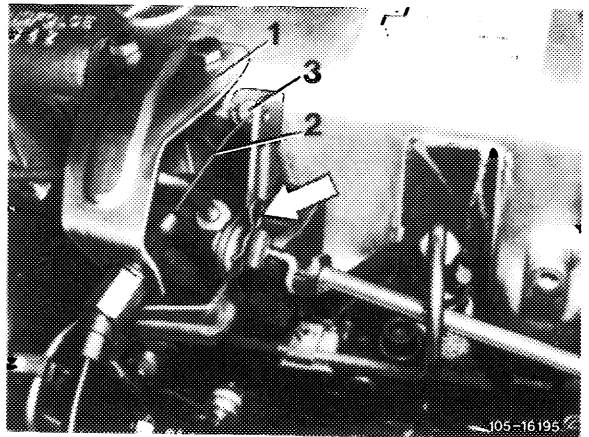

3 On engines with tension rail version (A) remove chain tensioner. On vehicles with air-conditioners, detach York A/C compressor together with connected lines, depositing on one side. However, first remove fan and water pump pulley, removing air cleaner cover on engines with oil bath air cleaners.

Drain coolant and detach thermostat body.

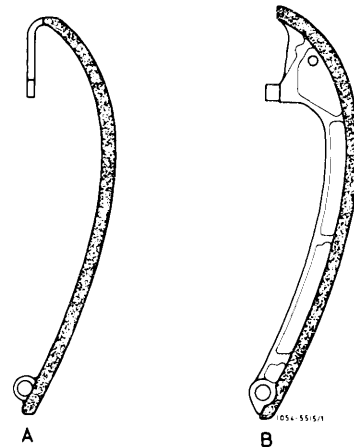

4 On engine 617.912, remove adapter at air cleaner.

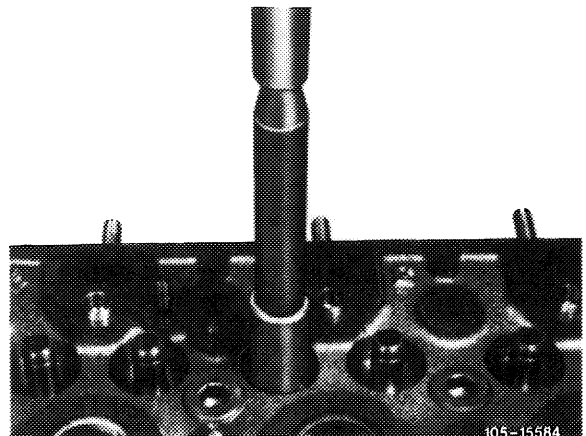

5 Turn crankshaft so that No. 1 cylinder piston is at TDC.

Turn crankshaft with tool combination for this purpose.

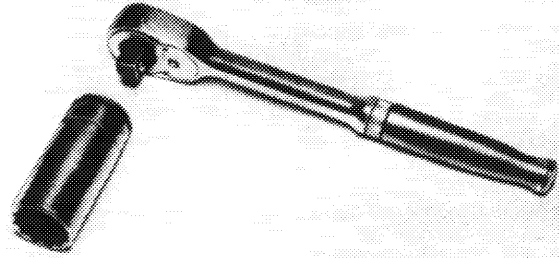

R 100/6498

6 Mark positions of camshaft sprocket and timing chain to show how they fit together.

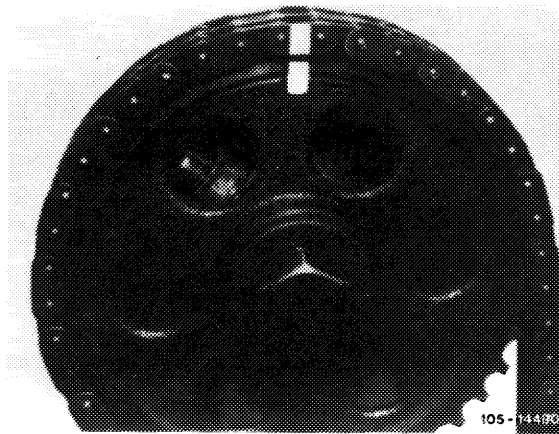

105-14470

7 Remove slide rail or rails from cylinder head.

Withdraw bearing pin using impact extractor.

On vehicles with 2nd tension rail version (B) force back thrust pin of chain tensioner (illustration, job No. 3).

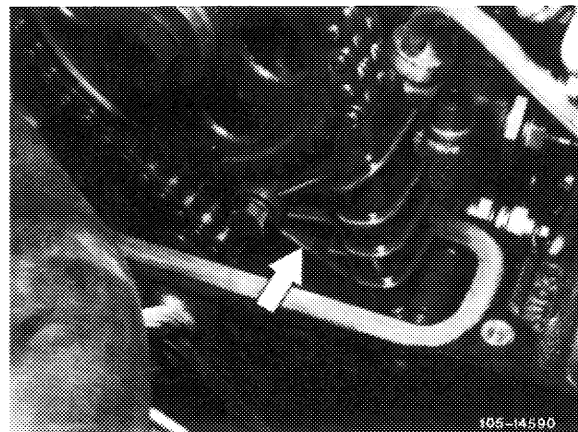

105-14690

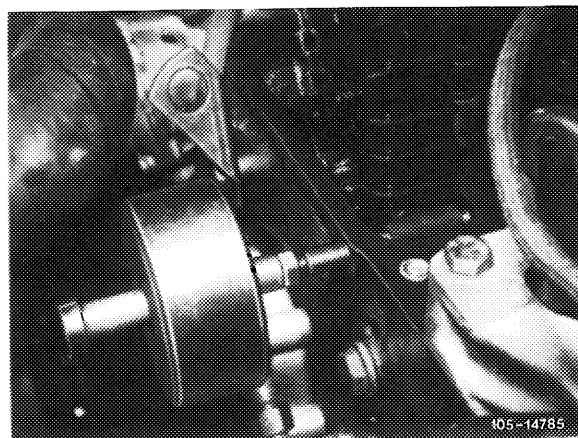

105-14785

8 Remove camshaft sprocket.

To release waisted bolt secure camshaft sprocket with screwdriver or steel pin.

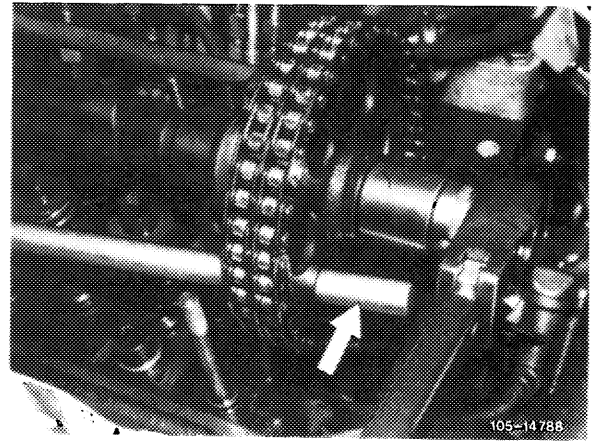

9 Remove screw plug (arrow).

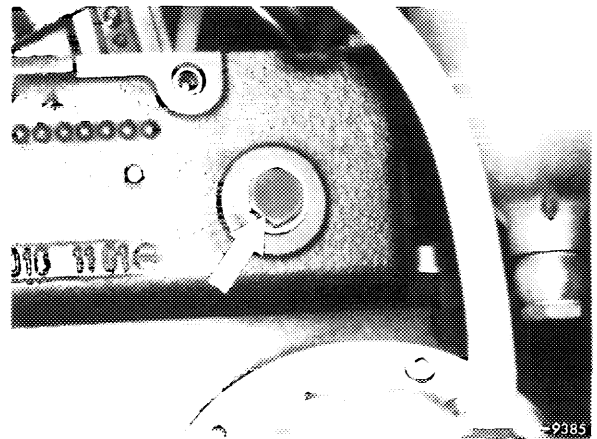

10 Using impact extractor, withdraw shaft (110) and remove idler gear (98a) in upward direction.

- 98a Idler gear
- 108 Screw plug
- 109 Sealing ring
- 110 Shaft

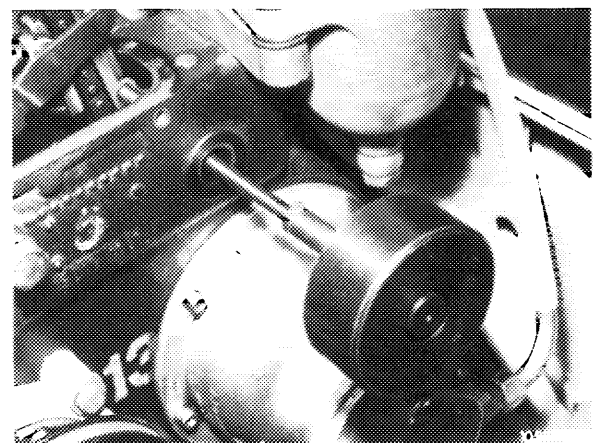
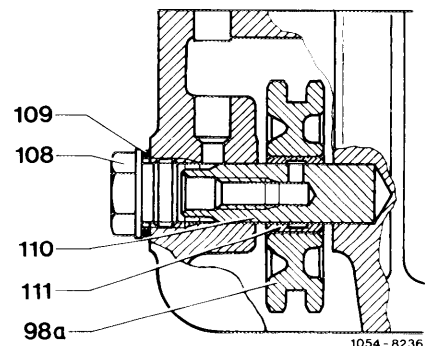

11 On vehicles with level control remove retaining bolt of front bearing bushing (arrow).

Withdraw shaft and bearing bushing, removing idler gear.

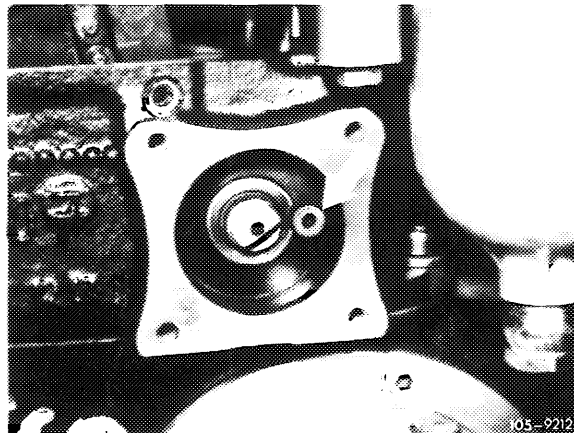

Installation

12 Position idler gear and insert shaft.

On models with level control insert bearing bushing bolt (arrow in illustration, job No. 11).

13 Insert screw plug with new sealing ring.

On vehicles with level control attach delivery oil pump with new gasket.

14 Fit camshaft sprocket with reference to markings. Torque waisted bolt to 80 Nm (8 kpm), securing camshaft sprocket with screwdriver or steel pin for this purpose.

15 Fit slide rail or rails.

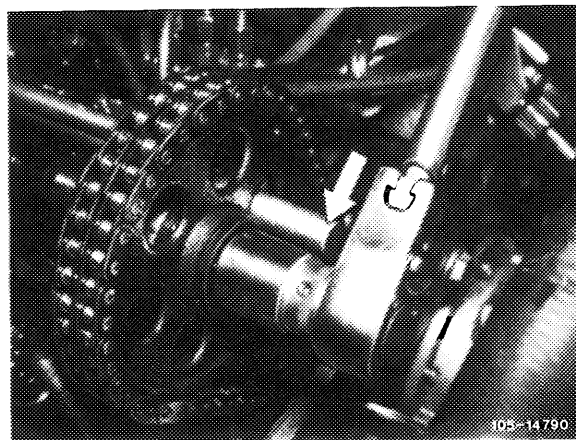

16 Turn crankshaft and check adjusting marks at engine TDC.

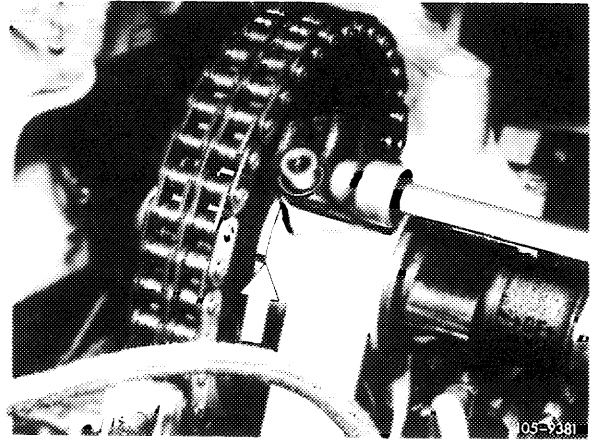

On engines with tension rail version (A) install chain tensioner (illustration, job No. 3).

Now proceed in reverse order of removal.

