

Recommended viscosity grades according to SAE at constant ambient temperatures

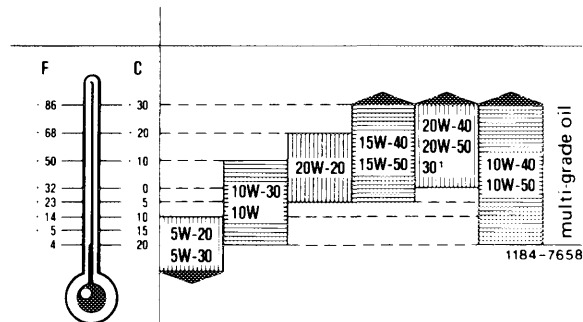

1) SAE 40 oil can be used at constant ambient temperatures above +30 °C (+86° F).

Oil quantity in liters (for approved engine oils refer to "Service product specifications")

Engine	615.912/913	615.940/941
	616.916	616.912
	617.910	617.912



Total quantity for refilling	6,5 ¹⁾	7,0 ¹⁾
------------------------------	-------------------	-------------------

¹⁾ 0.5 liters more for models with air-cooled oil coolers

Tightening torques

		Nm	(kpm)
Oil drain plug in oil pan	M 26	50	(5)
	M 12	40	(4)
Fastening bolt for lower part of oil filter (type 115.1)		40–45	(4.0–4.5)
Center bolt and nuts for oil filter cover (type 123.1)		20–25	(2.0–2.5)
Bolts for engine bearer at engine mount front (type 123.1)	M 12	70	(7)
	M 10	40	(4)
Nuts for engine stop on crossmember (type 115.1)		90	(9)
Adjusting screw for front engine stop (type 123.1)		130	(13)
Adjusting screw for rear engine mount	type 115.1	30	(3)
	type 123.1	40	(4)

Special tools

Torque wrench handle 20–100 Nm (2–10 kpm)		001 589 35 21 00
Torque wrench handle 50–200 Nm (5–20 kpm)		001 589 44 21 00
Ratchet for torque wrench handle		001 589 42 09 00

Pressure tester for cooling system and radiator cap

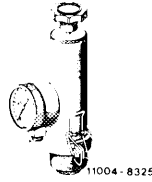

001 589 48 21 00

Radiator cap with hose for leakage test

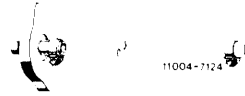

605 589 00 25 00

Stud-end/box-end wrench 14 x 17 mm



000 589 24 07 00

Oil removal syringe



112 589 00 72 00

Commercially available tool

Engine hoist (1.5 t lifting capacity)

e. g. Bäcker, 5630 Remscheid,
order No. 3178

Removal

- 1 On type 123.1, move engine hood to 90° position and latch left-hand locking lever (arrow).
- 2 Fully drain coolant.
- 3 Remove radiator.
- 4 On engine models 615 and 616, remove upper part of air filter. On engine model 617 in general and on engine models 615, 616 featuring injection pumps with mechanical governors, remove air filter.
- 5 On models with air-conditioner, detach A/C compressor together with bracket and connected pipes, and then put down on one side.

Remember to empty air-conditioner if A/C compressor is removed (83–516).
- 6 On models with level control, detach delivery oil pump together with connected lines. To do so, simply release bolts (arrows).

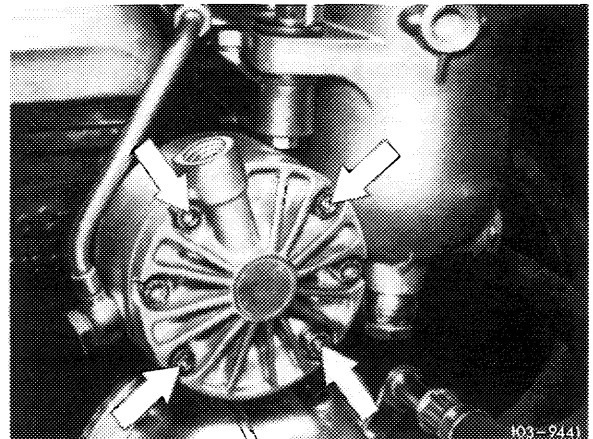
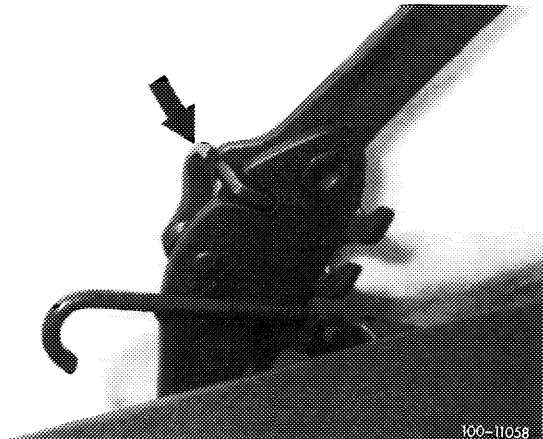

7 Draw oil out of power steering pump reservoir and disconnect hoses.

8 Unhook control linkage.

9 Disconnect all coolant, vacuum, oil, fuel and electric lines which lead to engine.

10 On uprated engines, remove longitudinal control shaft. To do so, unhook control rods, withdraw retaining ring (arrow) and force longitudinal control shaft backward.

11 On types 115.117, 123.105/130/150 and 123.102/103/120/123/126/183 featuring automatic transmission, unscrew engine shock absorbers. On type 115.114, release engine shock absorbers from bodywork and force out toward engine.

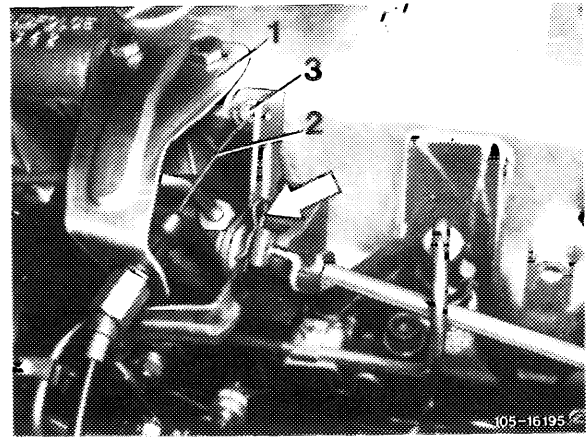

Type 115.114
Engine shock absorber left (straight-ahead)

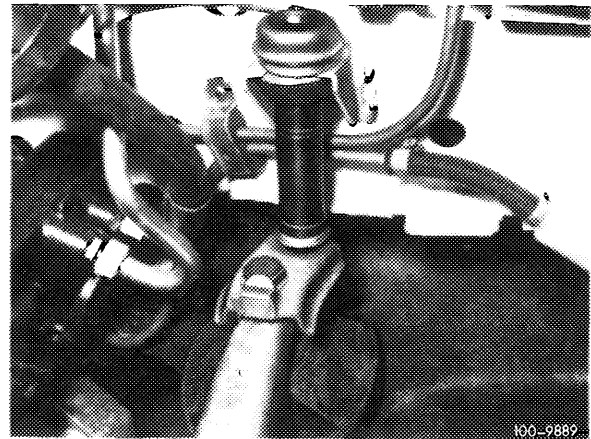

Type 115.114
Engine shock absorber right (straight-ahead)

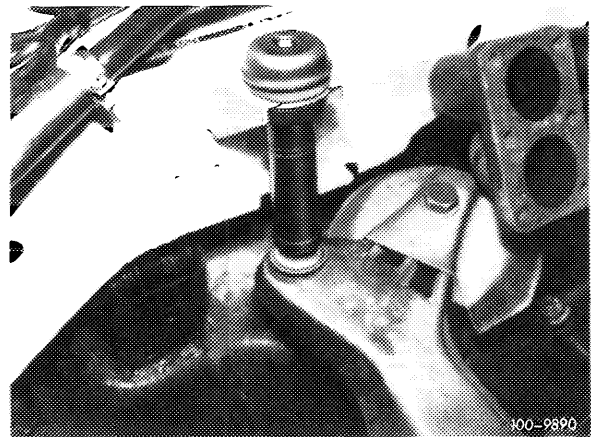

Type 115.117

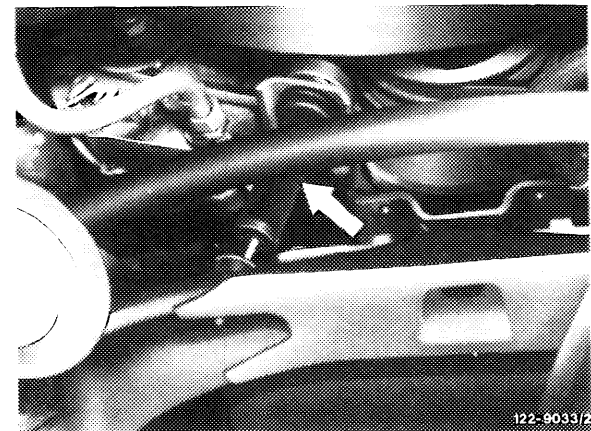

Types 123.102/103/120/123/126/183
featuring automatic transmissions

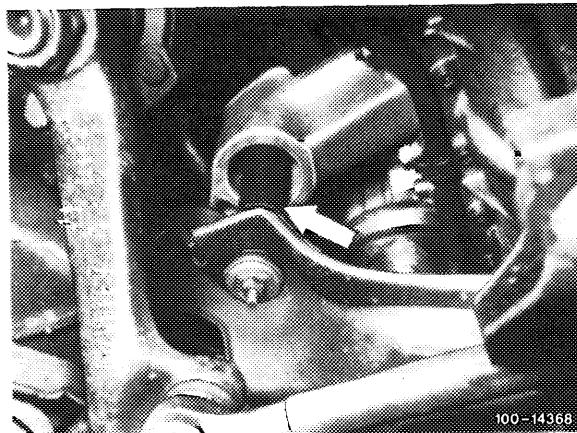

Types 123.105/130/150/190

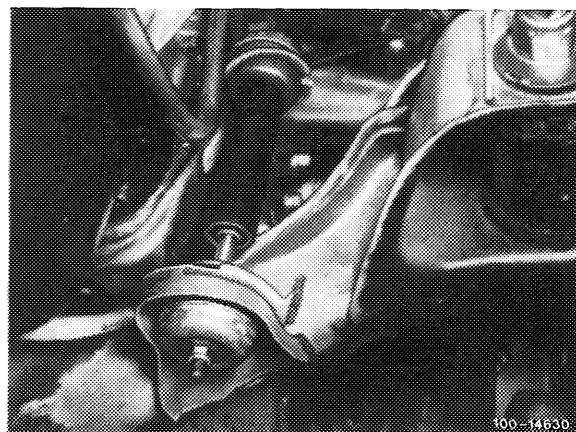

12 On types 115.110/115 and 123.1, unscrew engine stop.

On types 115.110/115, it is then necessary to unscrew self-locking nut (32) and withdraw adjusting screw.

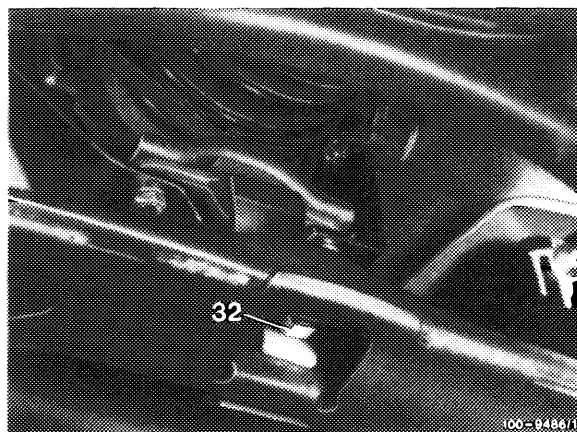

Types 115.110/115

On type 123.1 (with the exception of types 123.105/130/150/190 featuring two engine shock absorbers), lift up retainer (30) and swivel away to one side. Unscrew adjusting screw (31).

13 Unscrew exhaust at exhaust manifold and at lateral support on transmission.

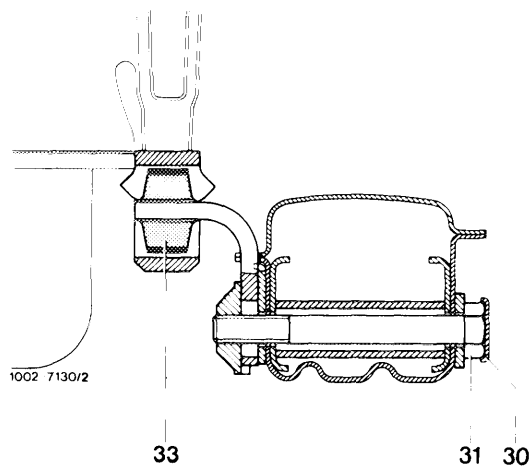

Type 123.1

14 On types 115.110/115/117 featuring automatic transmissions, unscrew steering shock absorber one side (arrow) and turn away.

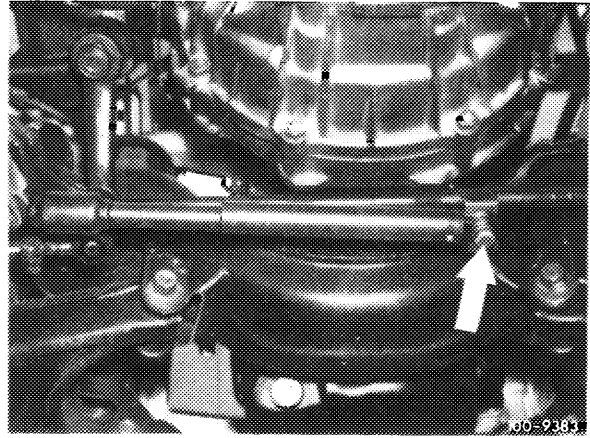

15 On type 123.1, unscrew engine bearer bolts at engine mount front, doing so from below. On type 115.1, work from above.

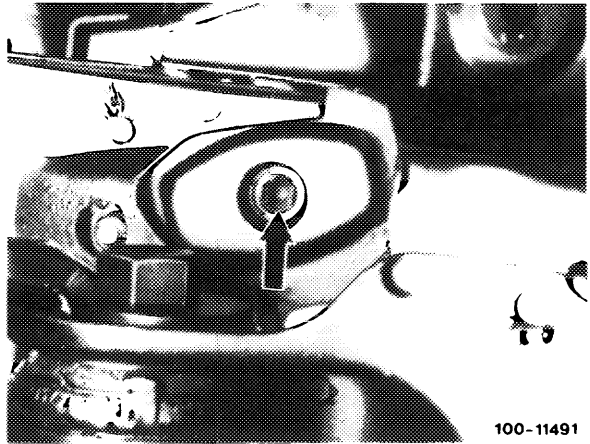

Type 123.1

100-11491

16 Unscrew propeller shaft at transmission.

17 Release all connections and shift rods at transmission.

18 Remove rear engine bearer with engine mount.

19 Attach engine hoist ropes to suspension lugs.

For engines in type 115.1, bolt one suspension lug to cylinder head at front. Use may be made of the suspension lug fitted to engines in type 123.1.

The rear suspension lug on engines in type 115.1 is located on the intermediate flange. For engine 617 in type 115.1, wrap the rear rope around engine.

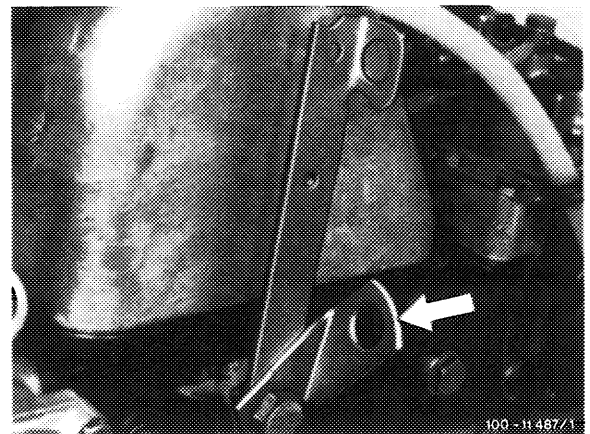

Front suspension lug, type 123.1

100-11487/1

Rear suspension lug, type 123.1

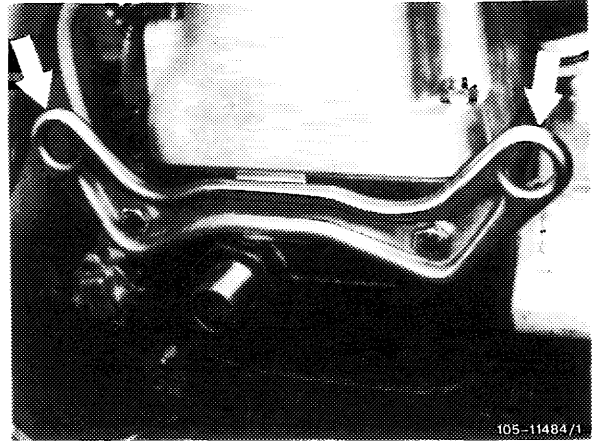

20 Lift engine and transmission up and out at about 45°.

View showing engine 617 in type 115.1

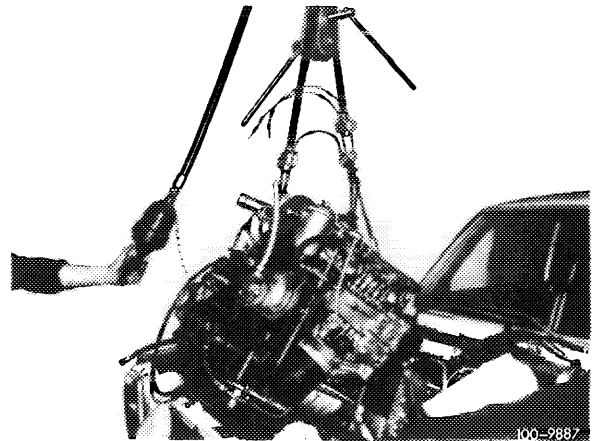

Installation

Caution:

When installing a new engine as a result of bearing failure, flush out the oil cooler, oil hoses, and clean oil filter housing.

21 Check engine mounts, engine shock absorbers, oil and fuel hoses, replacing if necessary.

22 Prior to attaching manual transmission to flange, check deep-groove ball bearing in crankshaft as well as clutch throwout unit, replacing if necessary.

23 Install and connect engine.

24 Attach and adjust propeller shaft (41-020).

- 25 Adjust engine stop (00–220).
- 26 Check all drain plugs for firm fit.
- 27 Fill with oils and coolant (20–010).
- 28 Pressure-test cooling system, using pressure tester.
Check coolant for antifreeze (20–010).
- 29 Clean air filter element, replacing if necessary.
- 30 Adjust idle speed (07.1–050).